



ST8109

FLUKE®

98

Automotive ScopeMeter® Series II

Users Manual

4822 872 00786

September 1996, Rev. 3, 3/97

©1996, 1997 Fluke Corporation. All rights reserved. Printed in the Netherlands.
All product names are trademarks of their respective companies.

Contents

- 1 INTRODUCING YOUR AUTOMOTIVE SCOPEMETER TEST TOOL**
 - INTRODUCTION 1-3
 - QUICK TOUR 1-4
 - POWER SOURCES 1-11
 - CHARGING THE BATTERY 1-12
 - USING THE KEYS 1-13
 - READING THE DISPLAY 1-16
 - MEASUREMENT CONNECTIONS 1-19
 - GROUNDING GUIDELINES 1-21

- 2 TUTORIAL**
 - INTRODUCTION 2-2
 - POWER ON/OFF/BACKLIGHT/CONTRAST 2-3
 - VEHICLE DATA SETUP 2-4
 - BATTERY VOLTAGE TEST 2-5
 - RESISTANCE MEASUREMENT 2-7
 - POTENTIOMETER TEST 2-9
 - OXYGEN SENSOR TEST 2-11
 - GENERAL SENSORS TEST 2-13
 - RPM MEASUREMENT 2-15
 - SECONDARY IGNITION SINGLE ON DIS 2-17
 - INJECTION TEST 2-19
 - RECORD PLOT READINGS 2-21
 - RECORD MIN MAX TRENDPLOT 2-23
 - RECORD INTERMITTENT RECORD 2-25
 - RECORD FLIGHT RECORD 2-28
 - SAVE/RECALL OF SCREENS 2-30
 - CURSOR KEY FUNCTION 2-32

- 3 USING THE AUTOMOTIVE SCOPEMETER TEST TOOL**
 - INTRODUCTION 3-3
 - MENU OVERVIEW 3-8
 - USING SENSOR FUNCTIONS 3-13
 - USING AIR/FUEL FUNCTIONS 3-20
 - USING IGNITION FUNCTIONS 3-23
 - USING DIESEL FUNCTIONS 3-28
 - USING ELECTRICAL SYSTEM FUNCTIONS 3-30
 - USING SCOPE FUNCTIONS 3-37
 - USING MULTIMETER FUNCTIONS 3-47
 - CHANGING THE VEHICLE DATA AND INSTRUMENT SETUP .. 3-56

4 USING THE ADDITIONAL CAPABILITIES

USING THE RECORD FUNCTIONS	4-2
INTERMITTENT RECORD	4-8
FLIGHT RECORD	4-10
FREEZING, PRINTING, SAVING, AND RECALLING SCREENS ..	4-12
USING CURSORS	4-14
USING THE SMOOTH FUNCTION	4-16

5 AUTOMOTIVE APPLICATIONS

SENSORS	5-3
AIR/FUEL	5-37
IGNITION	5-57
ELECTRICAL SYSTEM	5-79
DIESEL	5-92

6 USER MAINTENANCE

CLEANING	6-2
KEEPING BATTERIES IN OPTIMAL CONDITION	6-2
REPLACING AND DISPOSING OF BATTERIES	6-4
FUSES NOT REQUIRED	6-5
CALIBRATING 10:1 TEST LEADS	6-6

7 APPENDIXES

APPENDIX 7A	Specifications	7-1
APPENDIX 7B	Parts and Accessories	7-14
APPENDIX 7C	PM8907 Information	7-17
APPENDIX 7D	Warranty and Service Centers	7-19
APPENDIX 7E	Terminology	7-21

INDEX

About This Manual

Chapter 1. Introducing Your Automotive ScopeMeter test tool.

This chapter introduces Automotive ScopeMeter[®] test tool features and capabilities. It starts with a 'Quick Tour' to give you a quick introduction to the Automotive ScopeMeter test tool.

Chapter 2. Tutorial

This chapter provides many demonstrations with use of the Demo Board to help you understand how the Automotive ScopeMeter test tool works.

Chapter 3. Using the Automotive ScopeMeter Test Tool

This chapter describes how to use the main functions of the Automotive ScopeMeter test tool. This includes the Automotive Test Functions, the Scope, and the Multimeter.

Chapter 4. Using the Additional Capabilities

This chapter describes the Automotive ScopeMeter test tool capabilities beyond the normal measurement functions, such as Recording, Saving and Recalling Screens, Cursors, and the Smooth Function.

Chapter 5. Automotive Applications

This chapter handles applications for the test tool, including descriptions, test setup (probes and test leads used and how to connect them), the operation sequence to perform the tests, the results you should see on the display, and analysis of the displayed results.

Chapter 6. User Maintenance

This chapter describes the cleaning of the Automotive ScopeMeter test tool and proper use and replacement of the battery pack. Periodic probe calibration is also covered here.

Chapter 7. Appendixes

- Appendix 7A. Specifications
Specifies the operating characteristics of the Automotive ScopeMeter test tool.
- Appendix 7B. Parts and Test Tool Accessories
Kit contents and parts ordering information.
- Appendix 7C. PM8907 Power Adapter Information.
Gives information about the Power Adapters for different local line voltages.
- Appendix 7D. Warranty and Service Centers
Warranty terms and Service Center addresses.
- Appendix 7E. Terminology
Defines terms you are likely to encounter when working with the Automotive ScopeMeter test tool.

Keystrokes

Keystrokes are represented in this manual with graphics of the keys. For example,  instructs you to press the MENU key.

Use of Terminology

Consult Appendix 7E 'TERMINOLOGY' at the back of the manual for explanations of unfamiliar terms.

UNPACKING

Check that the following items are included with your Automotive ScopeMeter test tool:

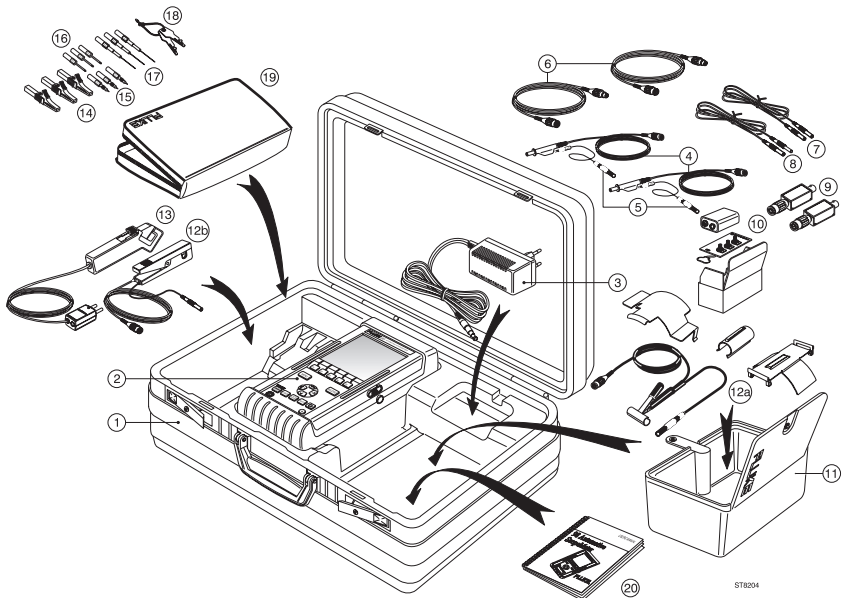

Carrying Case Contents

1. Automotive Hard Carrying Case C98.
2. Automotive ScopeMeter test tool in Yellow Holster, installed with NiCad Battery Pack (PM9086/011.)
3. 1 Power Adapter/Battery Charger PM8907/80*
 - * = 4 for UK, 240V, 50Hz
 - * = 1 for rest of Europe, 230V, 50 Hz
 - * = 3 for USA and Canada 120V, 60 Hz
 - * = 6 for Japan, 100V, 60 Hz
 - * = 7 for Australia, 240V, 50 Hz
 - * = 8 for other countries, selectable for 115V and 230V.

4. 2 Shielded Test Leads, red and grey (STL90).
5. 2 Ground Leads for STL90 Test Leads, black.
6. 2 BNC Extension Leads for STL90.
7. 1 Ground Lead (unshielded), black.
8. 1 Ground Extension Lead (unshielded), black.
9. 2 Filter Adapters (blue).
10. 1 Demo Board with 9V battery.
11. 1 Accessory Container
12. 1 Secondary Pickup being one of the following models (country dependent):
 - 12a CAP90-2 with three HEI (High Energy Ignition) Adapters.
 - 12b PM9096/01
13. 1 Inductive Pickup RPM90.
14. 3 Alligator Clips, red, grey, and black.
15. 3 4-mm Banana Adapters, grey, red, and black
16. 3 2-mm Adapters, red, grey, and black.
17. 3 Back Probe Pins, red, grey, and black.
18. 2 Keys for Case.
19. 1 Soft Case C75.
20. 1 Users Manual.

Check the contents for completeness, noting whether any damage has occurred during shipment. If something in the kit is damaged or missing, contact your distributor immediately.



WARNING

READ “SAFETY” BEFORE USING THE AUTOMOTIVE SCOPEMETER TEST TOOL.

SAFETY

The instrument described in this manual is designed to be used only by qualified personnel.

Safety Precautions

To use this instrument safely, it is essential that operating and servicing personnel follow both generally accepted safety procedures and the safety precautions specified in this manual.









Specific warning and caution statements, where they apply, will be found throughout the manual.

Where necessary, the warning and caution statements and/or symbols are marked on the instrument.

A CAUTION identifies conditions and actions that may damage the Automotive ScopeMeter test tool.

A WARNING IDENTIFIES CONDITIONS AND ACTIONS THAT POSE HAZARD(S) TO THE USER.

International symbols used are explained below.

	Caution (see explanation in manual)		DOUBLE INSULATION (Protection Class)
	Common input symbol, equipotentiality		Recycling symbol
	BNC signal input symbol		DC-Direct Current
	Earth (ground) terminal		AC-Alternating Current

The terms “Isolated” or “Electrically floating “ are used in this manual to indicate a measurement in which the Automotive ScopeMeter test tool COM (common, also called ground) is connected to a voltage different from earth ground. The term “Grounded” is used in this manual to indicate a measurement in which the Automotive ScopeMeter test tool COM (common) is connected to an earth ground potential.

The Automotive ScopeMeter test tool common connections (BNC shields of INPUT A and INPUT B, and the black 4-mm banana jack COM) are connected internally via self-recovering fault protection. The input connectors have no exposed metal and are fully insulated to protect against electrical shock. The black 4-mm banana jack COM (common) can be connected to a voltage above earth ground for isolated (electrically floating) measurements and is rated up to 600V rms above earth ground.

USING YOUR AUTOMOTIVE SCOPEMETER TEST TOOL SAFELY

Follow safe servicing practices as described in your vehicle service manual. To ensure that you use your Automotive ScopeMeter test tool safely, follow the safety guidelines below:

- Avoid working alone.
- Disconnect the power and discharge all high-voltage capacitors before connecting the Automotive ScopeMeter test tool to make resistance measurements.
- Inspect the test leads for damaged insulation or exposed metal. Check test lead continuity. Replace damaged leads before use.
- Do not use the Automotive ScopeMeter test tool if it looks damaged.
- Select the proper function and range for your measurement.
- Use caution when working above 60V dc, 42V peak, or 30V rms. Such voltages pose a shock hazard.
- When using the probes, keep your fingers away from probe contacts. Keep your fingers behind the finger guards on the probes.
- Disconnect the live test lead before disconnecting the common test lead.
- Do not perform internal service or adjustment of this product unless you are qualified to do so.



WARNING

DO THE FOLLOWING TO AVOID ELECTRICAL SHOCK BEFORE USING THE AUTOMOTIVE SCOPEMETER TEST TOOL:

- 1. MAKE SURE THAT THE VEHICLE TO BE TESTED IS AT A SAFE POTENTIAL BEFORE MAKING ANY MEASUREMENT CONNECTIONS.**
- 2. CONNECT THE COM INPUT OF THE TEST TOOL TO VEHICLE GROUND BEFORE CLAMPING THE STANDARD SUPPLIED SECONDARY PICKUP OR THE INDUCTIVE PICKUP ON THE IGNITION WIRES. THIS GROUND CONNECTION IS REQUIRED IN ADDITION TO THE NORMAL MEASUREMENT GROUND CONNECTIONS.**

WARNING

DO THE FOLLOWING TO AVOID ELECTRICAL SHOCK IF THE GROUND OF THE AUTOMOTIVE SCOPEMETER TEST TOOL IS CONNECTED TO A VOLTAGE HIGHER THAN 42V PEAK (30V RMS):

- 1. USE ONLY THE TEST LEAD/PROBE SET SUPPLIED WITH THE AUTOMOTIVE SCOPEMETER TEST TOOL (OR SAFETY-DESIGNED EQUIVALENTS WITHOUT EXPOSED METAL CONNECTORS).**
- 2. DO NOT USE CONVENTIONAL EXPOSED METAL BNC OR BANANA PLUG CONNECTORS IF THE GROUND POTENTIAL OF THE AUTOMOTIVE SCOPEMETER TEST TOOL IS HIGHER THAN 42V PEAK (30V RMS).**
- 3. USE ONLY ONE GROUND CONNECTION TO THE AUTOMOTIVE SCOPEMETER TEST TOOL (GROUND LEAD OF THE PROBE ON INPUT A).**
- 4. REMOVE ALL PROBES AND TEST LEADS THAT ARE NOT IN USE.**
- 5. USE ONLY THE SUPPLIED PROBE TIP ADAPTERS OR 600V RATED TYPES.**
- 6. CONNECT THE PM8907 POWER ADAPTER TO THE AC OUTLET BEFORE CONNECTING IT TO THE AUTOMOTIVE SCOPEMETER TEST TOOL.**

WARNING

DO NOT USE THE AUTOMOTIVE SCOPEMETER TEST TOOL IN ENVIRONMENTS WHERE EXPLOSIVE PETROLEUM VAPOR MAY COLLECT (SUCH AS IN BELOW-GROUND PITS OR WITHIN 18 INCHES (45cm) OF THE FLOOR.)



Ni-Cd



Cd

This instrument contains Nickel Cadmium batteries. Do not mix with the solid waste stream. Spent batteries should be disposed of by a qualified recycler or hazardous materials handler. Contact your authorized Fluke Service Center for recycling information.

DECLARATION OF CONFORMITY

for

FLUKE 98 Automotive ScopeMeter® Series II

Manufacturer

Fluke Industrial B.V.
Lelyweg 1
7602 EA Almelo
The Netherlands

Statement of Conformity

Based on test results using appropriate standards, the product is in conformity with

Electromagnetic Compatibility Directive 89/336/EEC
Low Voltage Directive 73/23/EEC

Sample tests

Standards used:

EN 61010-1 (1993)

Safety Requirements for Electrical Equipment
for Measurement, Control, and Laboratory Use

EN 50081-1 (1992)

Electromagnetic Compatibility Generic Emission Standard:
EN55022 and EN60555-2

EN 50082-1 (1992)

Electromagnetic Compatibility Generic Immunity Standard:

IEC801-2, -3, -4, -5

The tests have been performed in a typical configuration.

This Conformity is indicated by the symbol , i.e.
"Conformité européenne".

Chapter 1

Introducing your Automotive ScopeMeter Test Tool

INTRODUCTION	1-3
QUICK TOUR	1-4
A Look at the Test Tool	1-4
Using the Tilt Stand	1-5
Accessories Overview	1-5
Powering the Test Tool	1-6
Adjusting the Display Contrast	1-7
Resetting the Test Tool	1-7
Performing a Navigation Exercise	1-8
POWER SOURCES	1-11
Minimizing Signal Noise	1-11
CHARGING THE BATTERY	1-12
Saving Battery Life	1-12
USING THE KEYS	1-13
Keypad Overview	1-13
Key Descriptions	1-14
READING THE DISPLAY	1-16
Menu Display and 'ON-LINE HELP'	1-16
Getting Extended Information During Menu Selection	1-16
Result Display and 'ON-LINE HELP'	1-17
Getting Information About the Function Keys During a Running Test ..	1-18
MEASUREMENT CONNECTIONS	1-19
INPUT A (Red)	1-19
INPUT B (Grey)	1-19
COM, TRIGGER	1-19
TRIGGER (as single input)	1-19
COM (as single input)	1-20
GROUNDING GUIDELINES	1-21
Problems with Incorrect Grounding	1-21
Test Tool Grounding for Measurements on the Ignition System	1-22

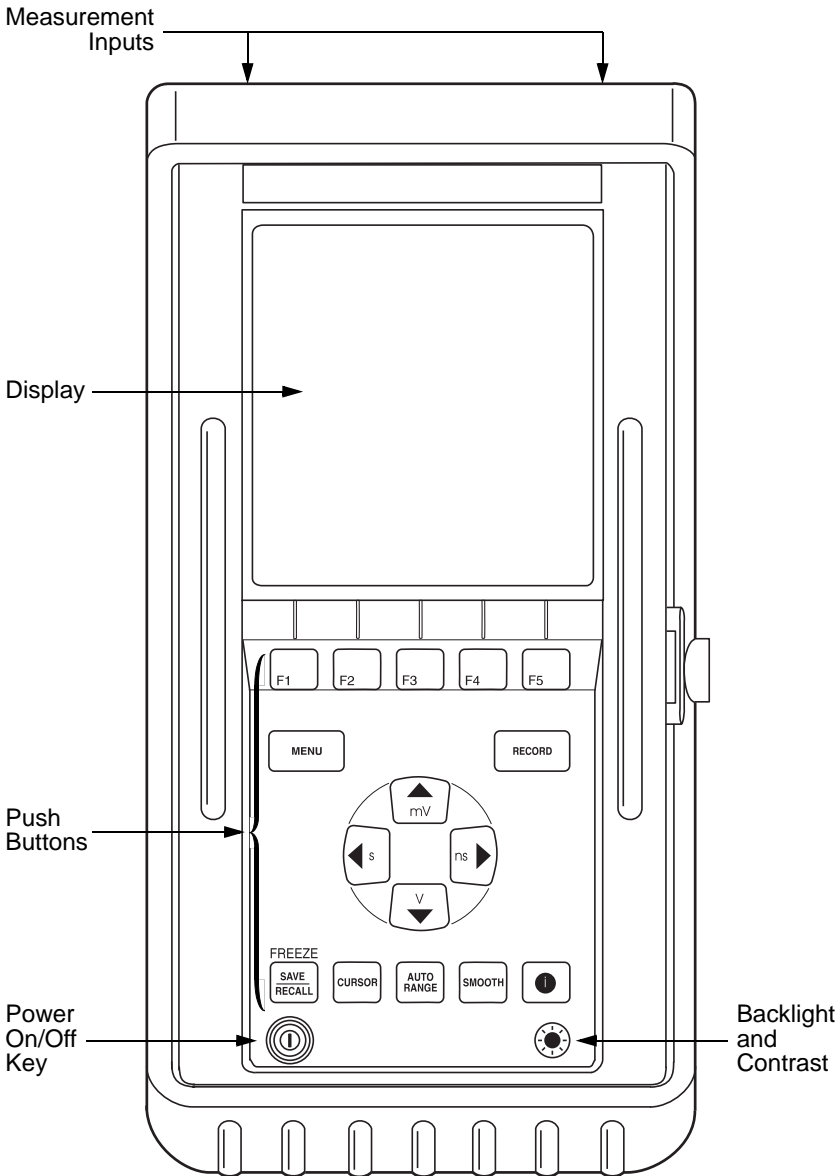

ST8036

INTRODUCTION

Your new Fluke Automotive ScopeMeter® test tool is a powerful instrument with a wide variety of capabilities.

- Its menu-driven interface has automatic configurations for most of your tests, so you will find that the test tool is easy to use.
- Continuous AUTO RANGE, an exclusive Fluke feature, constantly acquires and displays the best possible signal.
- The secondary ignition pickup and automated ignition functions make it easy for you to analyze an ignition system malfunction.
- The Relative Compression mode helps you quickly find a low compression cylinder.
- The Secondary Ignition Single function displays the waveform along with the spark voltage, RPM, burn time and burn voltage.

Many problems you will encounter are under a load - on a road test.

- The Intermittent Record function can find and display such a problem. This record function can record up to 1280 divisions of continuous information.
- The Flight Record function records screen snapshots from 200ms per division up to full time base speed.
- The Plot Readings function allows you to plot up to four different readings of a signal over time with a single connection.
- Min/Max Trendplot continuously monitors the minimum, maximum, and average value of a signal's readings with time stamp.

The Automotive ScopeMeter test tool has a wide variety of accessories, designed to enhance the test tool's measurement power.

- The optional diesel accessories allows you to set injection pump timing and rpm with confidence.
- The optional 90i-610s Current Probe will let you measure and analyze electrical system problems quickly and easily.
- The optional TR90 Temperature probe makes oil, surface, and air temperature measurements safe and easy.
- Test lead extensions are included for most of your long distance measurements.
- A wide variety of probes and clips are included to make connection to the vehicle quick and easy. Additional probes are available as accessories, easily connecting to the test leads.

Even though your instrument has been designed to configure itself to almost any test, review the following chapters to find out how easy test and measurement can be.

Using the Tilt Stand

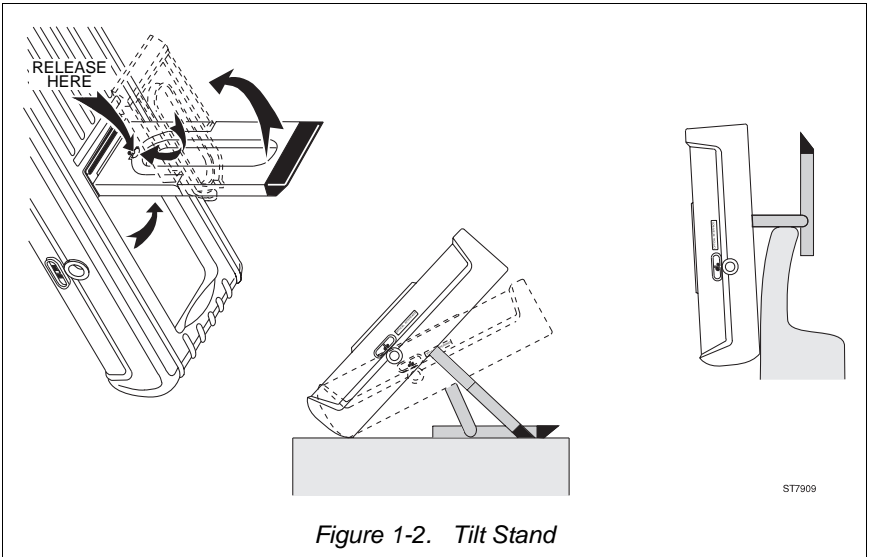

Accessories Overview

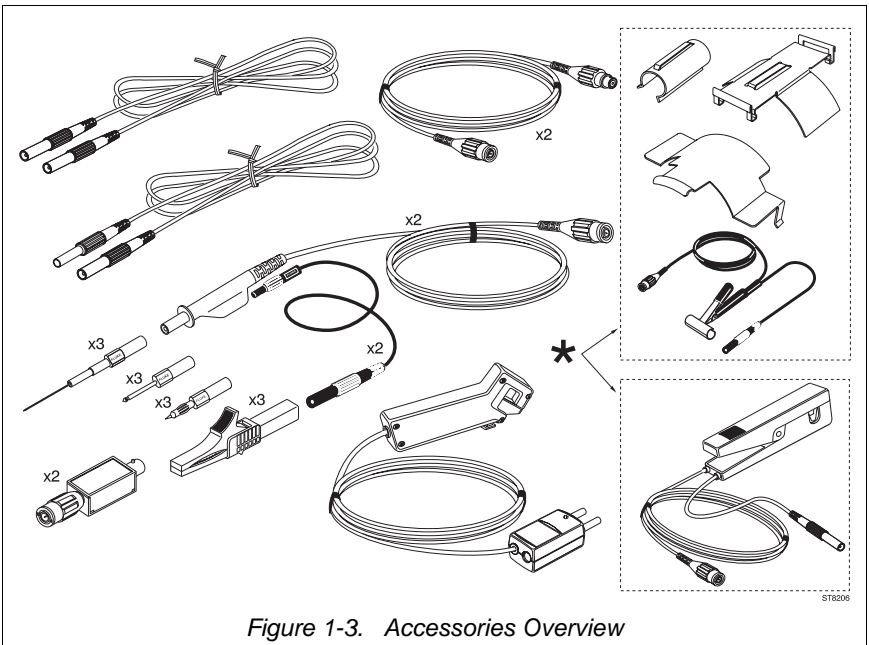

* Alternative (country dependent) delivery

Powering the Test Tool

Perform the following steps to power the test tool (see Figure 1-4).

- ① Make sure the Power Adapter is suitable for the local power line voltage (see Appendix 7C).
- ② Take the Power Adapter and connect the line power plug to the lines.
- ③ Connect the low voltage plug to the test tool as shown in Figure 1-4. This supplies the automotive test tool and charges the internal rechargeable NiCad Battery Pack. At delivery, the NiCad batteries may be discharged and must be charged for 16 hours to charge them completely.
- ④ Press the **ⓘ** key (Power on/off) to turn the test tool on.

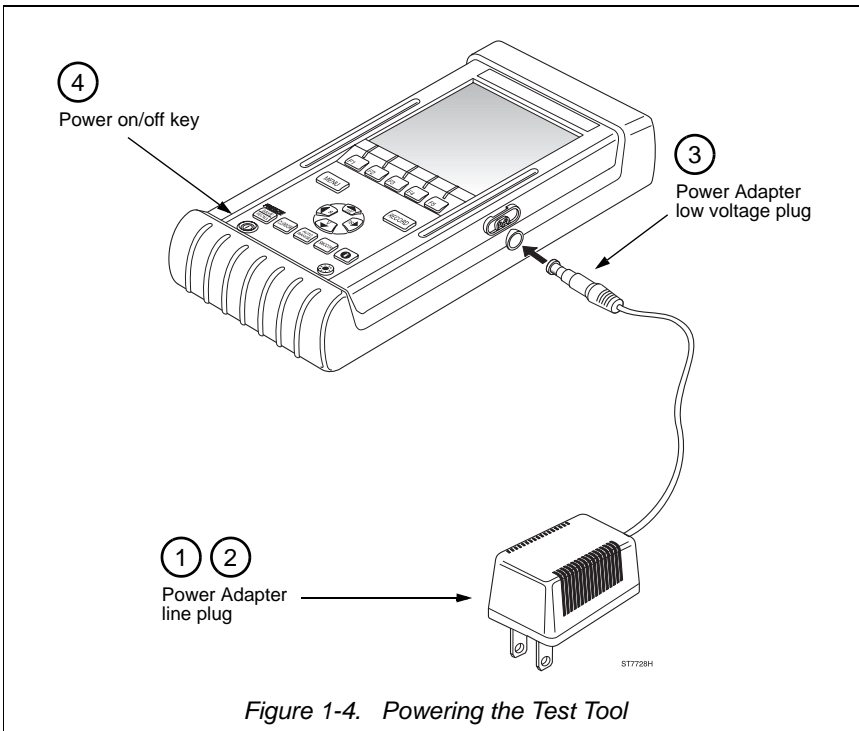
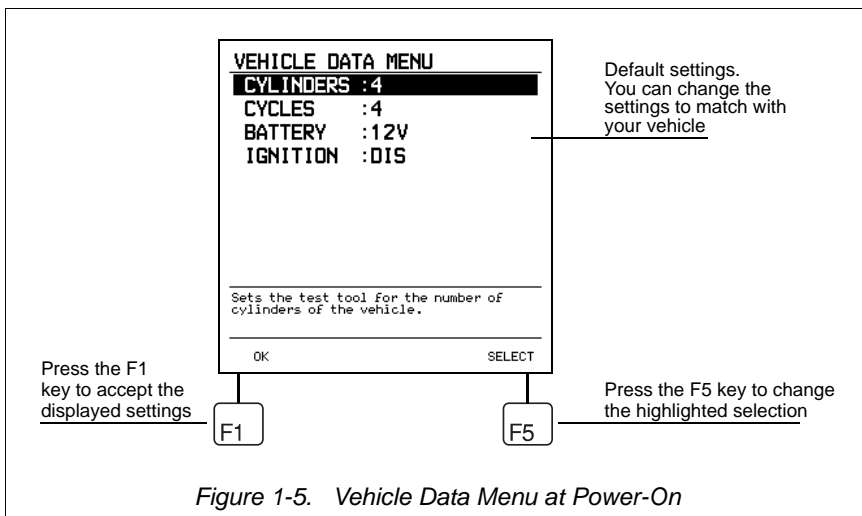

Figure 1-4. Powering the Test Tool

At power on, the test tool displays the model identification data. Press any key to display the vehicle data menu as shown in Figure 1-5.



Adjusting the Display Contrast



Press this key and keep it depressed until you can clearly read the display.

Resetting the Test Tool

If you want to restore the test tool settings as delivered from the factory, do the following:

Turn the test tool off by pressing the  key.

NOTE:

The following action clears all memory data.



Keep this key depressed while you turn the power on with the  key.

Release the F5 key. You will hear a double beep to indicate that the Master Reset has been executed.

Performing a Navigation Exercise

Subsequently follow steps ①, ②, and ③ in Figure 1-6 to select a test via menu control.

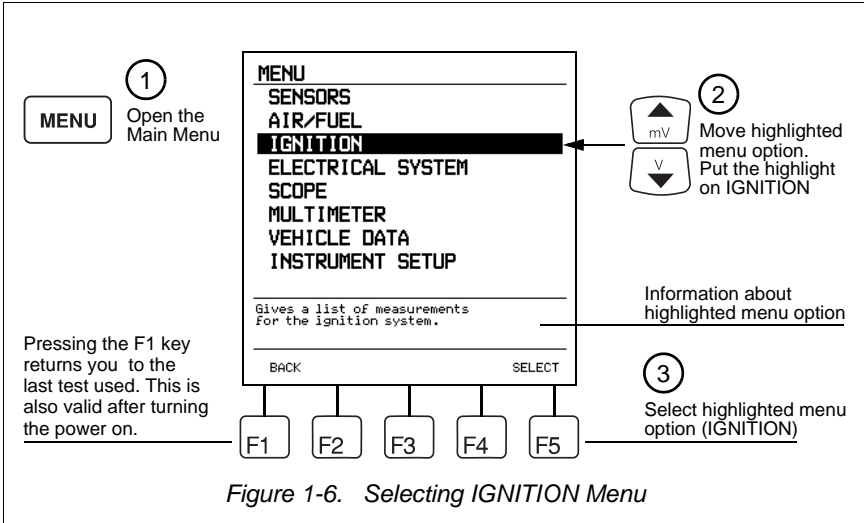

Subsequently follow steps ① and ② in Figure 1-7 to select SECONDARY IGNITION test.

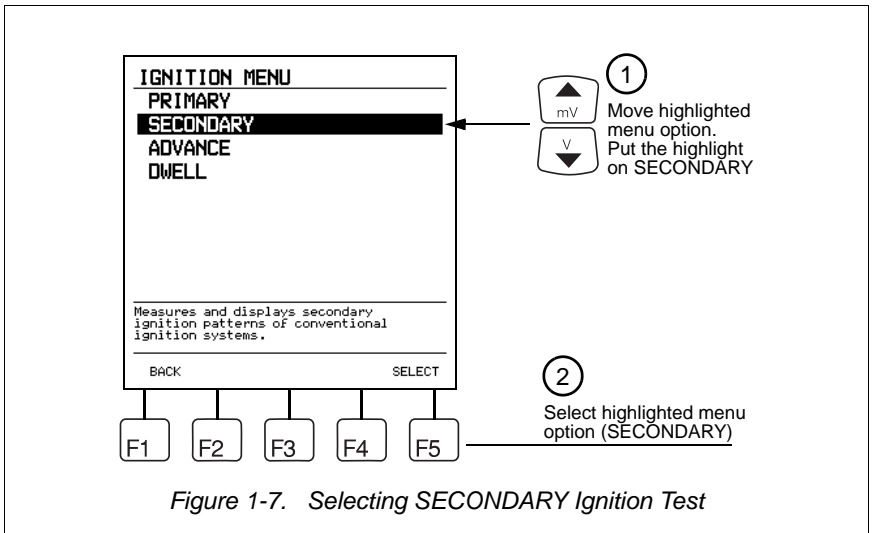

After you have selected the test you want, the display tells you what test leads you need and how to connect them (See Figure 1-8). This 'Connection Help' can be turned off. See 'Changing Instrument Setup' under OPTIONS MENU in Chapter 3.

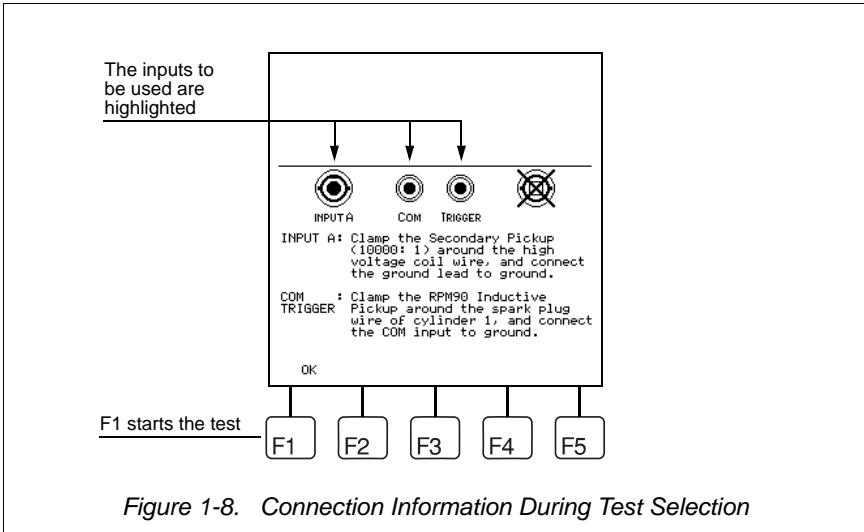

Figure 1-8. Connection Information During Test Selection

Press **F1** to start the test. For this example, it is not necessary to make the actual connections.

The test tool now runs the secondary ignition parade test. Note that PARADE is highlighted on the bottom display.

Press the information key **i** to display information about the present test being performed.

POWER SOURCES

You can power the automotive test tool from any of the following sources (refer to Figure 1-9):

- Internal Battery Pack (PM9086/011). ¹⁾
This is a rechargeable NiCad Battery Pack already installed.
- Four C Cell batteries can be used in place of the NiCad Battery Pack.
These batteries can be used in combination with one of the following adapters, but charging is disabled.
- Power Adapter PM8907. ²⁾
The Power Adapter/Battery Charger powers the test tool from a standard ac outlet and charges the installed PM9086/011 NiCad Battery Pack. The test tool can be used during battery charging. Verify that your local line voltage is appropriate before using the Power Adapter/Battery Charger to power the test tool.
- Charging Adapter PM9087/002 (optional).
This adapter charges the test tool's NiCad Battery Pack from a standard 12V dc cigarette lighter outlet.
- Charging Adapter PM9087/021 (optional).
This adapter charges the test tool's NiCad Battery Pack from a standard 24V dc cigarette lighter outlet.

- 1) Refer to Chapter 6 'USER MAINTENANCE' for battery replacement instructions.
- 2) Refer to Appendix 7C for information about local versions.

Minimizing Signal Noise

In general, noise pickup is minimized when you use the test tool on its internal battery power. Using the STL 90 Shielded Test Leads will help in noise rejection.

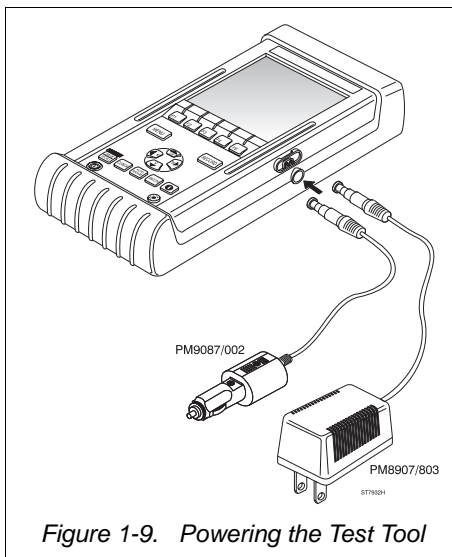

Figure 1-9. Powering the Test Tool

CHARGING THE BATTERY



WARNING

TO AVOID ELECTRICAL SHOCK, USE A BATTERY CHARGER THAT IS AUTHORIZED FOR USE WITH THE AUTOMOTIVE SCOPEMETER TEST TOOL.

Use the following procedure to charge the battery pack and to power the test tool:

1. Connect the Power Adapter/Battery Charger to line voltage.
2. Insert the Power Adapter/Battery Charger low voltage plug into the Power Adapter connector of the test tool. You can now use the test tool while the NiCad batteries charge slowly. If the test tool is turned off, the batteries charge more quickly.

During operation, when the batteries are low, a blinking battery symbol  appears on the top right of the display. When this occurs there is about 10 minutes of operating time left.

3. The Power Adapter/Battery Charger uses a trickle charge for the batteries, so no damage can occur if you leave it charging for long periods, e.g., through the weekend. Typically a 16-hour recharge provides the maximum use of 4 hours.

Saving Battery Life

When operated on batteries (no adapter connected), the test tool conserves power by shutting itself down. If you have not pressed a key for 5 minutes or if the battery level is too low, the test tool beeps and displays a message. This message prompts you to turn off the test tool or to continue. If you do not press a key during the next 5 minutes, the test tool turns itself off automatically.

Automatic power shutdown will not occur during recording.

USING THE KEYS

Keypad Overview

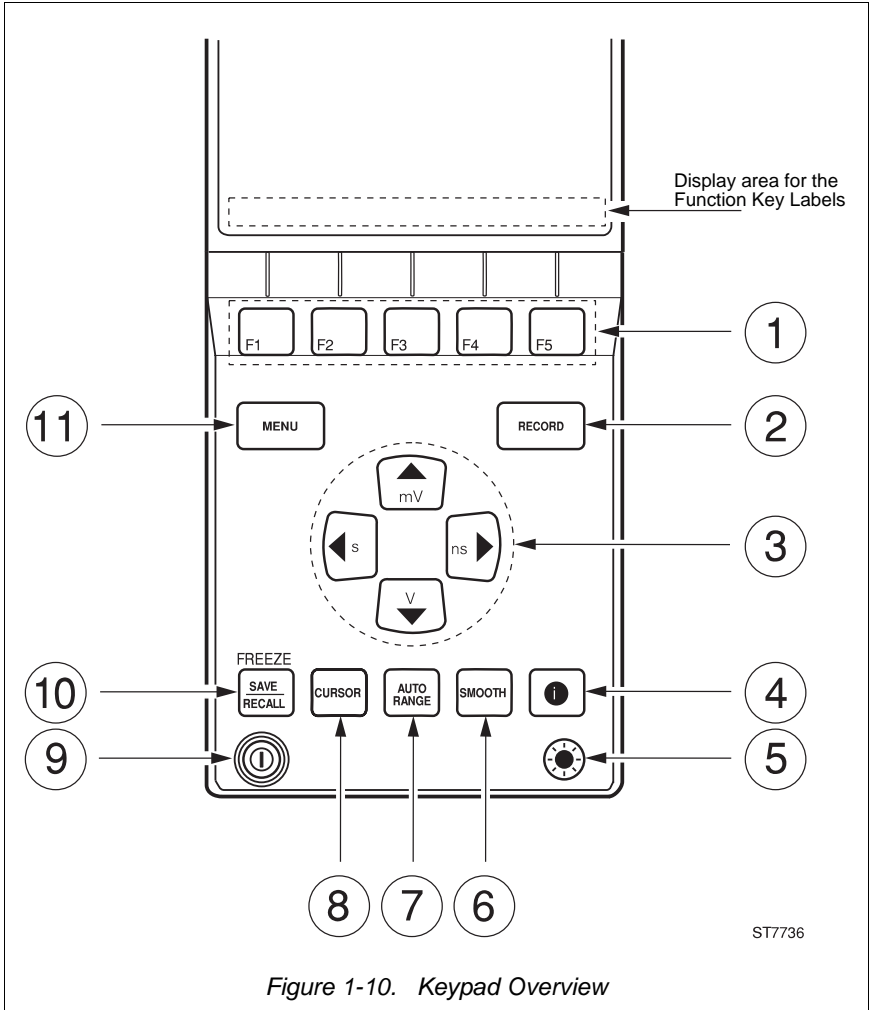

















Figure 1-10. Keypad Overview

Key Descriptions

ITEM	KEYS	DESCRIPTION
①	 to 	These are the Function Keys. The function assigned to each key is indicated by the Function Key Label displayed above the key on the bottom display.
②		Displays the menu for recording functions. These functions plot and store test data over a long period of time.
③	 	Performs one of the following actions: <ul style="list-style-type: none"> ● Moves up and down through menu choices. ● Ranges amplitude up and down. ● Moves a waveform up and down. ● Adjusts the trigger level when you are in the SCOPE function.
	 	Performs one of the following actions: <ul style="list-style-type: none"> ● Ranges Time Base up and down. ● Moves a waveform right and left. ● Moves cursor left and right.
④		Displays information about the highlighted menu choice during menu selection. Displays information about the function keys when a selected test is running.
⑤		Changes the LCD Backlight intensity (low, medium, high.) You can change the display contrast when you keep the key depressed.
⑥		Allows you to increase and decrease the damping of the displayed waveform and readings. By increasing the damping, you can remove noise from the signal so that the displayed waveform looks smoother and readings become more stable. When you decrease the damping, noise and glitches (spikes) may be visible.

ITEM	KEYS	DESCRIPTION
⑦		Sets automatic ranging on and off (toggle). When on, the top right display shows AUTO. When this function is set on, it searches for the best range and time base settings and once found it tracks the signal. When this function is off, you should manually control ranging.
⑧		Allows you to use cursors for measurements on waveforms. A cursor is a vertical line that you can move over the waveform like a ruler to measure values at specific points.
⑨		Turns the power on and off (toggle.) When you turn the power on, previous settings are activated.
⑩	FREEZE 	Freezes the display (HOLD is displayed at the top right). Also displays a menu to save, recall, and print screens.
⑪		Takes you back to the main navigation menu.

READING THE DISPLAY

Menu Display and 'ON-LINE HELP'

During menu selection, the bottom part of the screen is used to display the function key menu. Above it, brief information is displayed about the highlighted menu option to help you in making the right choice.

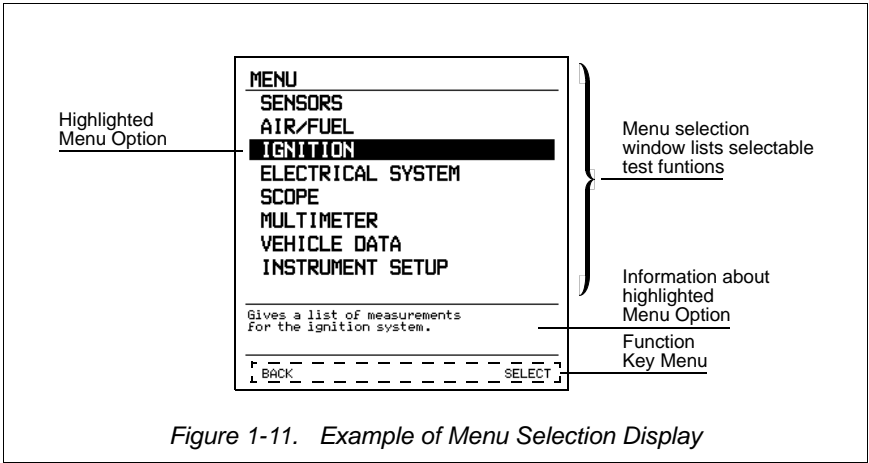
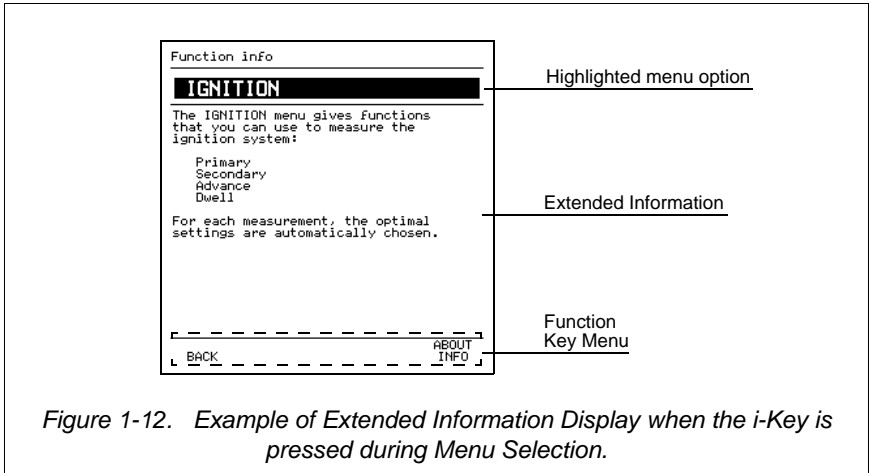

Figure 1-11. Example of Menu Selection Display

Getting Extended Information During Menu Selection



When you press this key, you get extended information about the highlighted menu option. See Figure 1-12.



BACK



Press this key to return to the menu selection display.

Result Display and 'ON-LINE HELP'

Most measurement results are displayed as a waveform with related numerical values. See an example display in Figure 1-13.

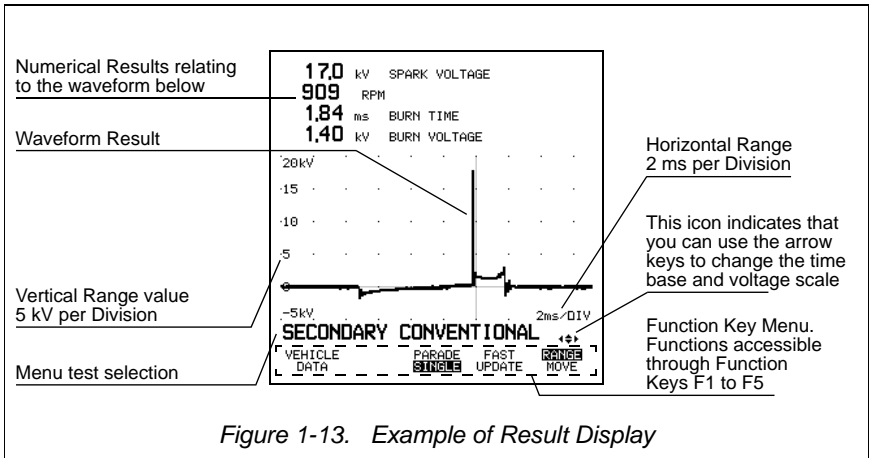

Getting Information About the Function Keys During a Running Test



When you press this key during a running test, you get information about the function keys that can be used for the test. For the test shown in Figure 1-13, this will display the information shown in Figure 1-14.

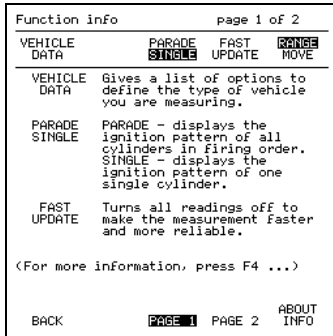



Figure 1-14. Information About the Function Keys



Press this key to read further information on page 2.

BACK



Press this key to return to the test display or press the  key again.

MEASUREMENT CONNECTIONS

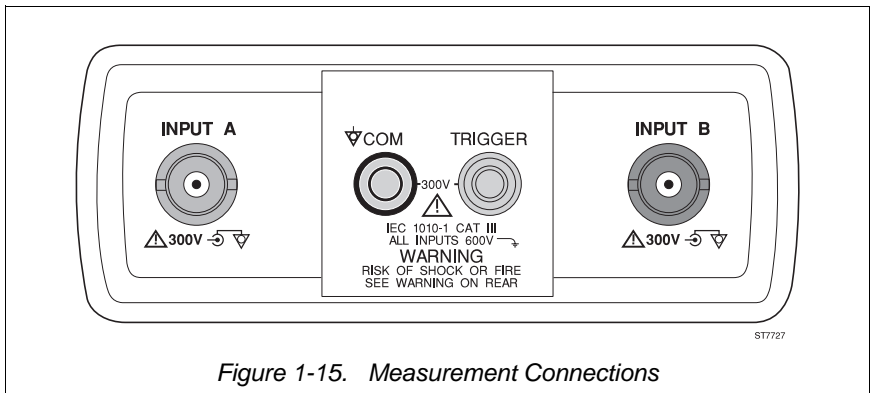

Figure 1-15. Measurement Connections

INPUT A (Red)

INPUT A is used for all single channel measurements, sometimes combined with use of the other inputs. You may need various test leads and adapters, depending on the type of measurement selected.

INPUT B (Grey)

INPUT B is used in conjunction with INPUT A:

- For ADVANCE measurements.
- For DUAL OXYGEN SENSOR measurements.
- In SCOPE functions you can use the test tool as a dual trace oscilloscope with INPUT A and INPUT B connected.

COM, TRIGGER

Used as external trigger for probes with dual banana plugs, such as the RPM90 Inductive Pickup.

TRIGGER (as single input)

Used in SCOPE functions to start (trigger) acquisitions from an external source.

COM (as single input)

Used for safety grounding when the Inductive Pickup or the Secondary Pickup is connected to the ignition system.



WARNING

TO AVOID ELECTRICAL SHOCK, CONNECT THE COM INPUT OF THE TEST TOOL TO VEHICLE GROUND BEFORE CLAMPING THE STANDARD SUPPLIED CAPACITIVE SECONDARY PICKUP OR THE INDUCTIVE PICKUP ON THE IGNITION WIRES. THIS GROUND CONNECTION IS REQUIRED IN ADDITION TO THE NORMAL MEASUREMENT GROUND CONNECTIONS.

For other tests, the COM input should not be connected to engine ground when the probes have their own ground connection at the probe end. See the following **GROUNDING GUIDELINES**.

GROUNDING GUIDELINES

Problems with Incorrect Grounding

Incorrect grounding can cause various problems:

1. You can create a ground loop when you use two ground leads connected to different ground potentials. This can cause excessive current through the grounding leads.

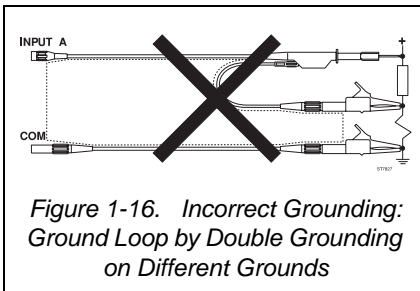

Figure 1-16. Incorrect Grounding: Ground Loop by Double Grounding on Different Grounds

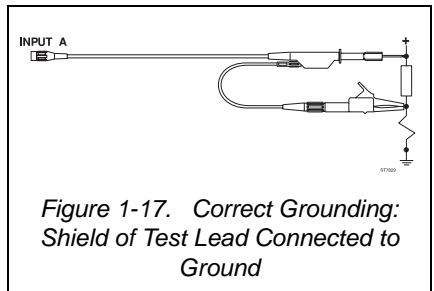

Figure 1-17. Correct Grounding: Shield of Test Lead Connected to Ground

2. Excessive noise shown on the measured signal.

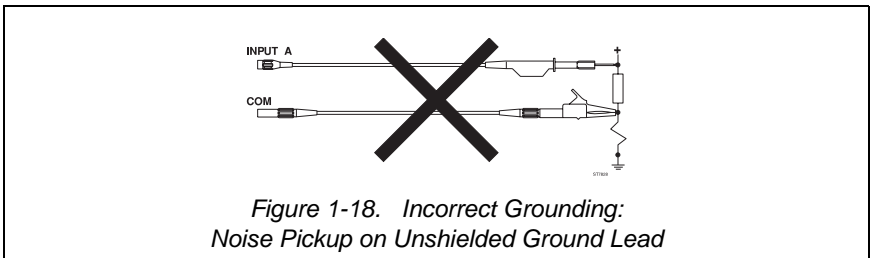

Figure 1-18. Incorrect Grounding: Noise Pickup on Unshielded Ground Lead

3. Measurement faults or short circuit with the DUAL INPUT SCOPE function. This occurs when you perform floating measurements with grounding at different points.

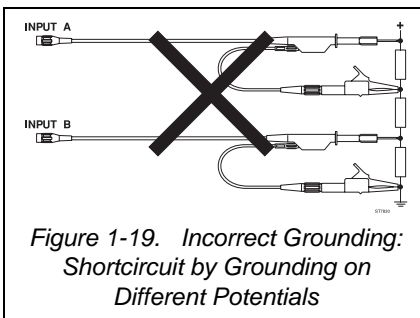

Figure 1-19. Incorrect Grounding: Shortcircuit by Grounding on Different Potentials

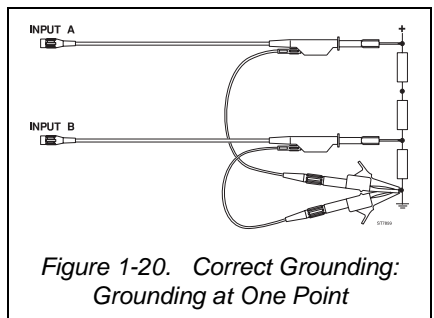

Figure 1-20. Correct Grounding: Grounding at One Point

Test Tool Grounding for Measurements on the Ignition System

For the safe use of the test tool, you must connect the COM input to engine ground before you perform measurements on the ignition system with the Secondary Pickup or the Inductive Pickup.

To prevent ground loops, connect all ground leads to the SAME engine ground.

Chapter 2

Tutorial

INTRODUCTION	1-2
POWER ON/OFF/BACKLIGHT/CONTRAST	1-3
VEHICLE DATA SETUP	1-4
BATTERY VOLTAGE TEST	1-5
RESISTANCE MEASUREMENT	1-7
POTENTIOMETER TEST	1-9
OXYGEN SENSOR TEST	1-11
GENERAL SENSORS TEST	1-13
RPM MEASUREMENT	1-15
SECONDARY IGNITION SINGLE ON DIS	1-17
INJECTION TEST	1-19
RECORD PLOT READINGS	1-21
RECORD MIN MAX TRENDPLOT	1-23
RECORD INTERMITTENT RECORD	1-25
RECORD FLIGHT RECORD	1-28
SAVE/RECALL OF SCREENS	1-30
CURSOR KEY FUNCTION	1-32

INTRODUCTION

This chapter demonstrates how to use several test functions of the Automotive ScopeMeter test tool. The Demo Board is used to supply the test signals necessary for the test simulation.

Figure 2-1 shows the setup used for this tutorial.

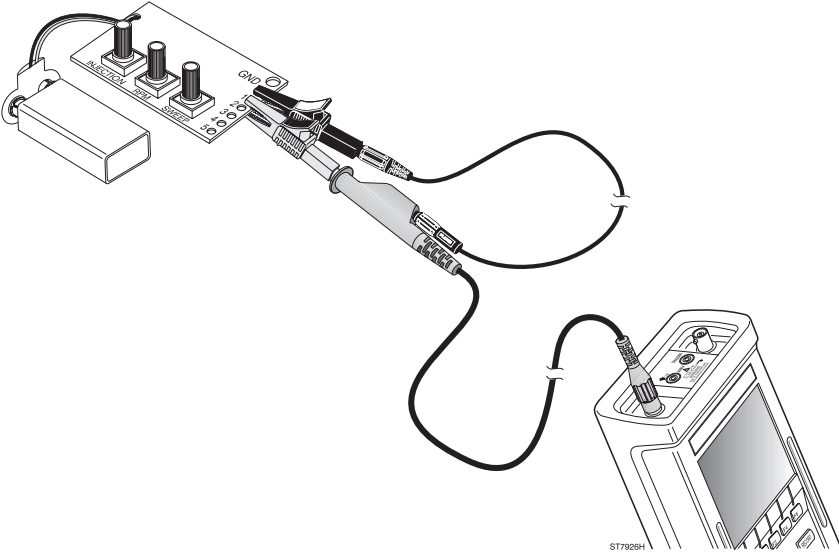





Figure 2-1. Tutorial Setup

POWER ON/OFF/BACKLIGHT/CONTRAST

POWER ON

- ① Press and release the power on/off key. The test tool beeps once and turns on. The display shows the test tool model data. Press any key to continue.

BACKLIGHT

-  Press and release the backlight key. The display backlight is set to the minimum intensity.
-  Press and release the backlight key. The display backlight is set to medium intensity.
-  Press and release the backlight key. The display backlight is set to the maximum intensity.



CONTRAST

-  Press and hold the backlight key until desired contrast is achieved on the display.

SWITCHING OFF

- ① Press and release the power on/off key. The test tool turns off.

MASTER RESET

-  Press and hold F5.
- ① Press and release the power on/off key. Release . The test tool turns on and beeps twice. The display shows the opening screen containing the model data. Please note that this Master Reset automatically erases **all memory data**.

Press any key to continue.

VEHICLE DATA SETUP

Exercise:

Set the Vehicle Data for the test tool as follows: 6 Cylinders, 4 Cycles, 12V, DIS Ignition. This same "vehicle" is used for the tutorial. After powering on and after the opening screen (see page 2-3), the instrument shows the VEHICLE DATA MENU.

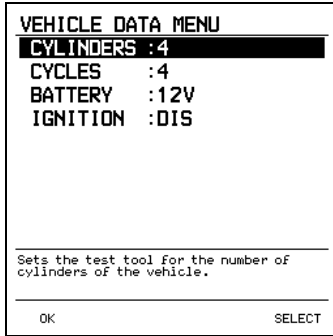

NO CHANGES



If no changes to the VEHICLE DATA are necessary, press the F1 key to confirm the selections and exit from the VEHICLE DATA MENU. Or you may press . This has the same effect.

TO MAKE A CHANGE:

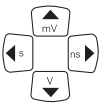

Use the arrow keys to select the menu line to change.



Press to SELECT the item to change.

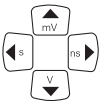

Use the arrow keys to set the variable within the pop-up selection window.



Press to SELECT the item to change.



Press to confirm the displayed Vehicle Data

BATTERY VOLTAGE TEST

A multimeter DC Voltage test

Exercise

Measure the voltage of the battery supplied with the Demo Board.

Steps



Press the MENU key to open the selection Menu.

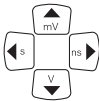

Use the arrow keys to highlight MULTIMETER.

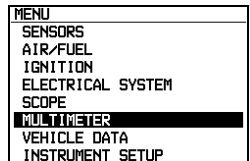

Press (SELECT) to confirm your selection (MULTIMETER).

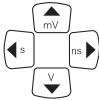

Use the arrow keys to highlight VOLT DC, AC.

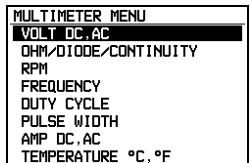

Press (SELECT) to confirm your selection (MULTIMETER VOLT DC, AC is activated).

Connection Help

A message on the display asks you to connect the red test lead from INPUT A to the item under test.

For this measurement, connect the red test lead to INPUT A, the red alligator clip to the + of the 9 volt battery, and the black alligator clip to the - of the battery. The battery is not connected to the Demo Board for this test.

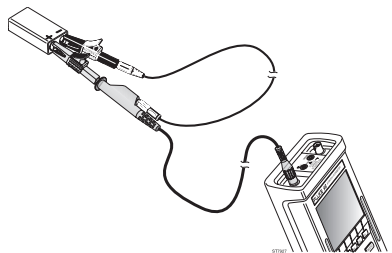

Press (OK) to confirm your connection.

Result

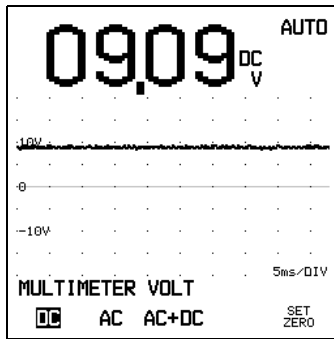

RESISTANCE MEASUREMENT

A Multimeter Resistance measurement.

Exercise

Measure the resistance of the potentiometer on the Demo Board.

Steps



Press MENU key to open the selection Menu.

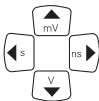

Use the arrow keys to highlight MULTIMETER.

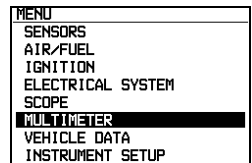

Press (SELECT) to confirm your selection (MULTIMETER).



Use the arrow keys to highlight OHM/DIODE/CONTINUITY.

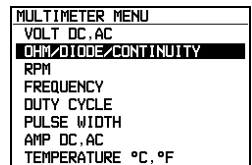

Press (SELECT) to confirm your selection (MULTIMETER OHM is activated).

Connection Help

A message on the display asks you to connect the red test lead to INPUT A and across the item to be tested.

For this measurement, connect the red test lead to INPUT A, the red alligator clip to TP 3, and the black alligator clip to the GND connection of the Demo Board.

The battery is not connected to the Demo Board.

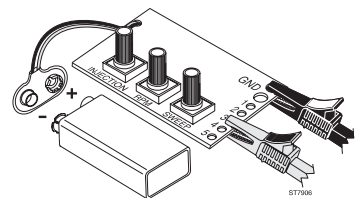

Press (OK) to confirm your connection.

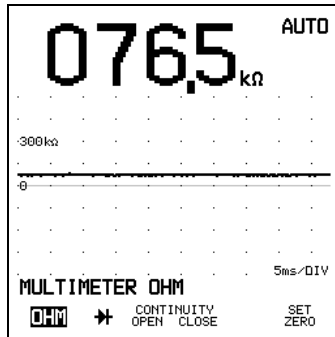
Result**Do**

Turn the SWEEP potentiometer and watch the value change on the display.

POTENTIOMETER TEST

The test tool can reveal noise or irregularities on potentiometers (variable resistors).

Exercise

Measure the noise/irregularity on the Demo Board potentiometer.

Steps



Press the MENU key to open the selection Menu.

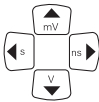

Use the arrow keys to highlight SENSORS.

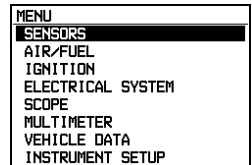

Press (SELECT) to confirm your selection (SENSORS).

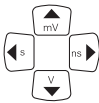

Use the arrow keys to highlight POTENTIOMETER.

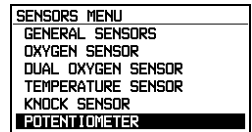

Press (SELECT) to confirm your selection (POTENTIOMETER is activated.)

Connection Help

A message on the display asks you to connect the test lead from INPUT A to the signal output of the potentiometer, and to the ground of the potentiometer.

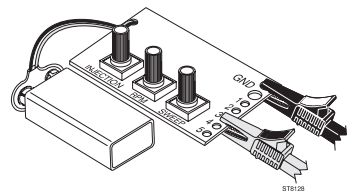

For this measurement, the battery is connected to the Demo Board. Connect the red test lead to INPUT A, the red alligator clip to TP 3 (potentiometer slider), and the black alligator clip to the GND of the Demo Board.



Rotate the SWEEP potentiometer, on the board, completely counterclockwise.



Press (OK) to confirm your connection.

Result

Do



Turn SWEEP potentiometer from completely counterclockwise to clockwise and watch the result. The waveform shows a rising edge.

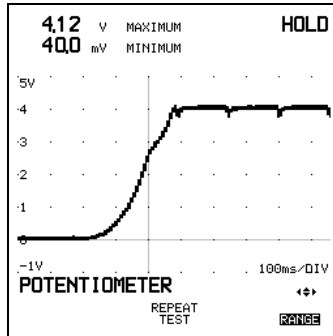

F3

Reset the test tool for a new measurement by pressing (REPEAT TEST).



Turn SWEEP potentiometer counterclockwise. The waveform shows a falling edge.

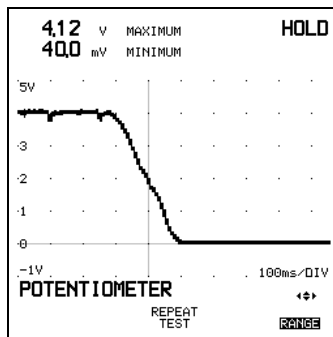

OXYGEN SENSOR TEST

The test tool automatically adjusts for any type of oxygen sensor, automatically shows the signal output of the sensor, and calculates the Maximum, Average, and Minimum values.

Exercise

Measure the simulated Oxygen sensor output signal from the Demo Board.

Steps



Press the MENU key to open the selection Menu.

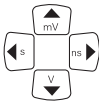

Use the arrow keys to highlight AIR/FUEL.



Press (SELECT) to confirm your selection (AIR/FUEL).

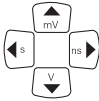
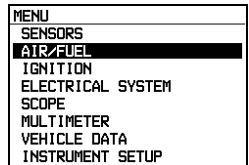

Use the arrow keys to highlight OXYGEN SENSOR.



Press (SELECT) to confirm your selection. (OXYGEN SENSOR test is activated.)

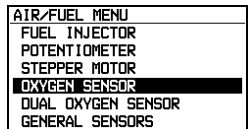

Connection Help

A message on the display asks you to connect the blue filter adapter and the red test lead from INPUT A to the oxygen sensor.

For this measurement, connect the red test lead to the blue filter adapter on INPUT A, the red alligator clip to TP 5 (OXYGEN SENS.), and the black alligator clip to the GND of the Demo Board.

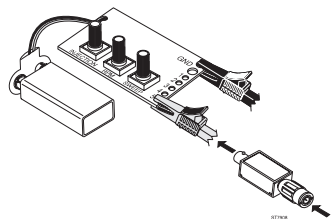

Press (OK) to confirm your connection.

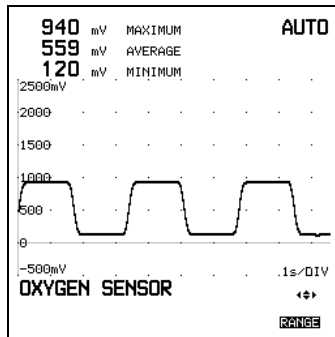
Result**Do**

Change the RPM potentiometer, and watch the OXYGEN SENS signal behavior on the display.

GENERAL SENSORS TEST

The test tool's General Sensors function optimally displays any signal, varying in amplitude and frequency.

Exercise

Measure the simulated Hall-Effect sensor output signal from the Demo Board (GEN.SENS signal).

Steps



Press the MENU key to open the selection Menu.

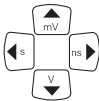

Use the arrow keys to highlight SENSORS.

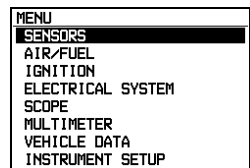

Press (SELECT) to confirm your selection (SENSORS).

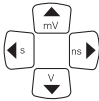

Use the arrow keys to highlight GENERAL SENSORS

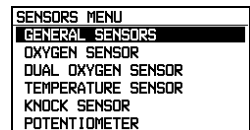

Press (SELECT) to confirm your selection (GENERAL SENSORS test is activated.)

Connection Help

A message on the display asks you to connect the red test lead from INPUT A to the sensor.

For this measurement, connect the red test lead to INPUT A, the red alligator clip to TP 4 (GEN. SENS.), and the black alligator clip to the GND connection of the Demo board.

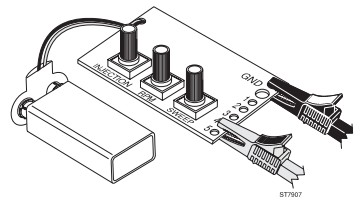

Press (OK) to confirm your connection.

Result

The test tool automatically scales and displays the waveform on the screen.

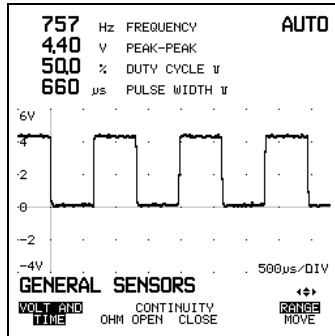

Do



Turn the RPM potentiometer and watch the result on the screen.

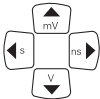

Press the up/down and left/right arrow keys, changing range, and watch the waveform appearance on the display.



Press the AUTO RANGE key, and the test tool automatically re-scales the waveform for an optimal display on the screen.

RPM MEASUREMENT

The test tool's Multimeter RPM function displays the incoming signal either through INPUT A or the TRIGGER input and calculates the RPM value.

Exercise

Measure the RPM of the GEN. SENS Signal on the Demo board.
Use different Divide factors (number of times the signal is present in 720°,
1 crankshaft revolution = 360°).

Steps



Press the MENU key to open the selection Menu.

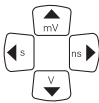

Use the arrow keys to highlight MULTIMETER.

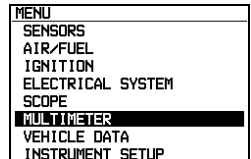

Press (SELECT) to confirm your selection (MULTIMETER).

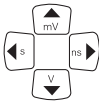

Use the arrow keys to highlight RPM.

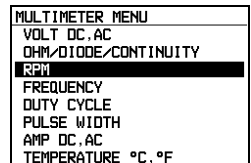

Press (SELECT) to confirm your selection (the RPM function is activated)

Connection Help

A message on the display asks you to connect the RPM90 Inductive Pickup.
Skip making this connection.



Press (OK) to enter the RPM measurement.



Press to highlight INPUT A as the input for the RPM signal.

Connection Help

A message on the display asks you to connect the red test lead from INPUT A to any RPM signal . For this measurement we use the General Sensor signal of the Demo board. Connect the red test lead to INPUT A, the red alligator clip to TP 4 (GEN. SENS.), and the black alligator clip to the GND connection of the Demo board.

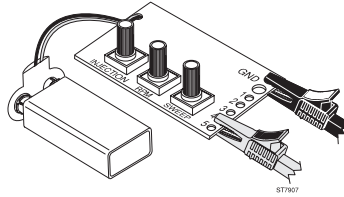

Press (OK) to confirm your connection.

Result

The test tool automatically scales and displays the waveform on the screen.

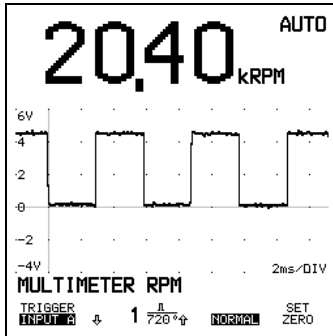

Do



Turn the RPM potentiometer and watch the result on the screen.

Press **F2** or **F3** and change the dividing factor accordingly. Then watch the RPM number change accordingly. (1 = DIS waste spark; 2 = conventional ignition system, etc.)

SECONDARY IGNITION SINGLE ON DIS

The test tool's Ignition function optimally displays the ignition signal and automatically calculates all relevant ignition parameters, such as spark voltage, rpm, burn time, and burn voltage.

Exercise

Measure the simulated Secondary DIS Ignition signal from the Demo Board. For setting DIS, refer to 'Vehicle Data Setup' on page 2-4.

Steps



Press the MENU key to open the selection Menu.

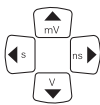

Use the arrow keys to highlight IGNITION.

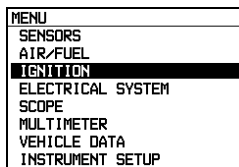

Press (SELECT) to confirm your selection (IGNITION).

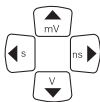

Use the arrow keys to highlight SECONDARY.

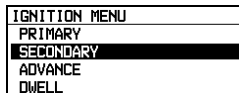

Press (SELECT) to confirm your selection (SECONDARY ignition test is activated).

Connection Help

A message on the display asks you to connect the Secondary Pickup to INPUT A and around the spark plug wire, and to connect the COM input to engine ground.

For this measurement we use the red test lead, since the Demo Board is not able to generate a High Voltage Secondary Signal. Connect the red test lead to INPUT A, the red alligator clip to TP 2 (SEC. IGN.), and the black alligator clip to the GND connection of the Demo board.

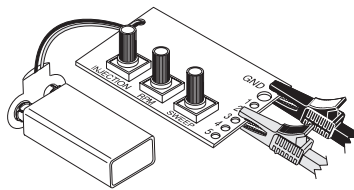

Press (OK) to confirm your connection.

Result

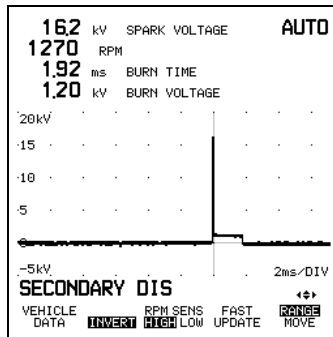

Do



Press (FAST UPDATE) to increase the update speed of the screen. Note that the readings will disappear.

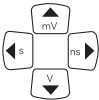

Use the arrow keys to change amplitude and time base.



Press Auto Range to select the default setting again.

INJECTION TEST

The test tool's Injection test function displays the injection signal and automatically calculates all relevant parameters, such as injection time and maximum peak voltage.

Exercise

Measure the simulated injection signal from the Demo Board.

Steps



Press the MENU key to open the selection Menu.

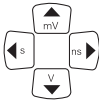

Use the arrow keys to highlight AIR/FUEL.

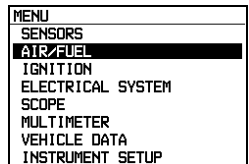

Press (SELECT) to confirm your selection (AIR/FUEL).

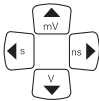

Use the arrow keys to highlight FUEL INJECTOR.

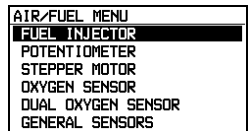

Press (SELECT) to confirm your selection (FUEL INJECTOR test is activated).

Connection Help

A message on the display asks you to connect the red test lead from INPUT A to the signal wire of the injector and to connect the ground lead to ground.

For this measurement, connect the red test lead to INPUT A, the red alligator clip to TP 1 (INJECTION), and the black alligator clip to the GND connection of the Demo board.

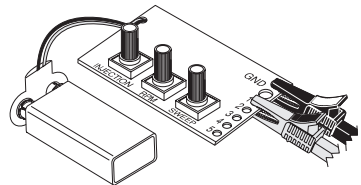

Press (OK) to confirm your connection.

Result

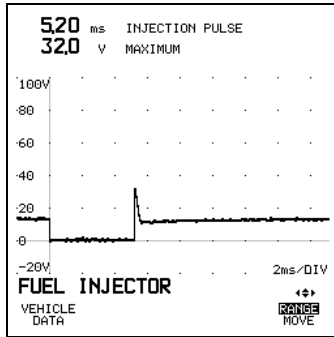

Do



Change the injection time by changing the INJECTION potentiometer.

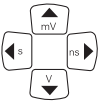

Use the arrow keys to change the timebase and amplitude.

RECORD PLOT READINGS

The test tool's PLOT READINGS function can record incoming signals by plotting up to FOUR different parameters over time.

Exercise

Record the General Sensor signal frequency range from the Demo Board.

Steps



Press the MENU key to open the selection Menu.

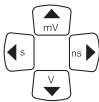

Use the arrow keys to highlight MULTIMETER.



Press (SELECT) to confirm your selection (MULTIMETER).

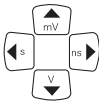
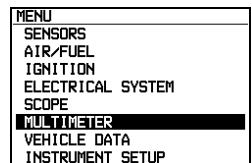

Use the arrow keys to highlight FREQUENCY.



Press (SELECT) to confirm your selection (FREQUENCY test is activated).

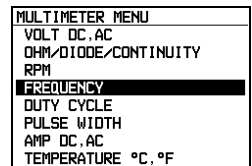

Connection Help

A message on the display asks you to connect the red test lead from INPUT A to the signal under test.

For this measurement, connect the red test lead to INPUT A, the red alligator clip to TP 4 (GEN.SENS.), and the black alligator clip to the GND connection of the Demo board.

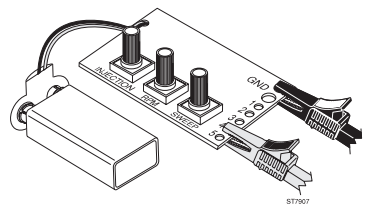

Press (OK) to confirm your connection.

Result

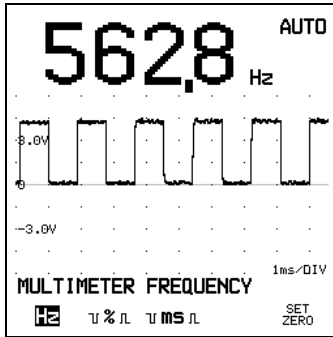

The Next Step

RECORD

Press to display the RECORD menu.

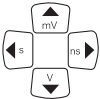

Use the arrow keys to select PLOT READINGS.

```

RECORD
PLOT READINGS
MIN MAX TRENDPLOT
FLIGHT RECORD
INTERMITTENT RECORD
VIEW RECORDED SIGNAL
  
```

F5

Press (SELECT) to confirm your selection (PLOT READINGS test is activated).

If there is old record data in memory, press F1 (YES) to continue.

```

The present contents of the
record memory will be lost.
Are you sure?
YES NO
  
```

Result

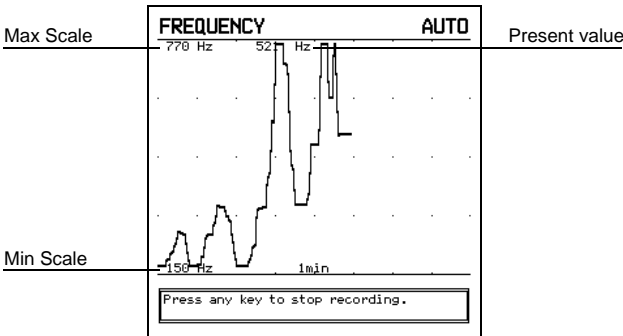

Do



Change frequency by changing the RPM potentiometer and watch the display.

To stop the Recording, press any key.

RECORD MIN MAX TRENDPLOT

The test tool's MIN MAX TRENDPLOT function records incoming signals and plots Minimum, Maximum, and Average over time.

Exercise

Record the minimum and maximum injection times of the simulated injection signal from the Demo Board.

Steps



Press the MENU key to open the selection Menu.

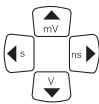

Use the arrow keys to highlight AIR/FUEL.

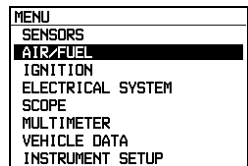

Press (SELECT) to confirm your selection (AIR/FUEL).

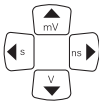

Use the arrow keys to highlight FUEL INJECTOR.

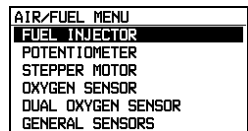

Press (SELECT) to confirm your selection (FUEL INJECTOR test is activated).

Connection Help

A message on the display asks you to connect the red test lead from INPUT A to the signal wire of the injector and to connect the ground lead to the vehicle ground.

For this measurement, connect the red test lead to INPUT A, the red alligator clip to TP 1 (INJECTION), and the black alligator clip to the GND connection of the Demo board.

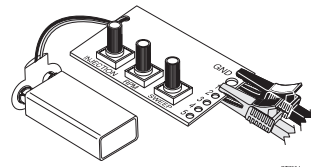

Press (OK) to confirm your connection.

Result

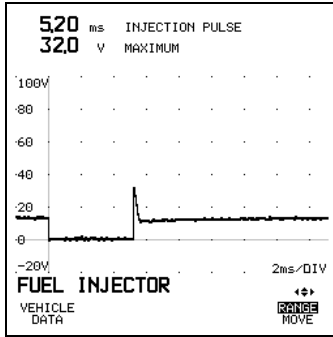

The Next Step

RECORD

Press to display the RECORD menu.

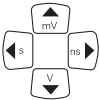

Use the arrow keys to highlight MIN MAX TRENDPLOT.

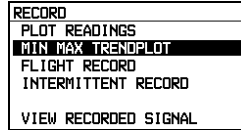

F5

Press (SELECT) to confirm your selection (MIN MAX TREND PLOT is activated). If there is old record data in memory, press F1 (YES) to continue.

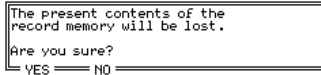

Result

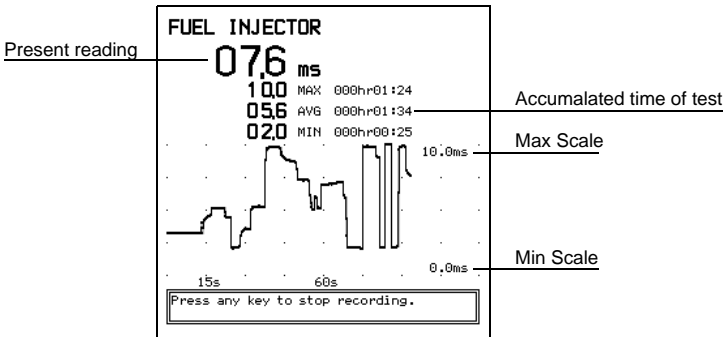

Do



Change frequency by changing the INJECTION potentiometer and watch the display.

To stop the Recording, press any key.

RECORD INTERMITTENT RECORD

The test tool's INTERMITTENT RECORD function records up to 1280 divisions (128 screens) of continuous signal data.

Exercise

Record the Ignition signal on the Demo Board over a long period of time. Refer to 'Vehicle Data' on page 2-4.

Steps



Press the MENU key to open the selection Menu.

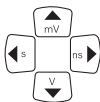

Use the arrow keys to highlight IGNITION.

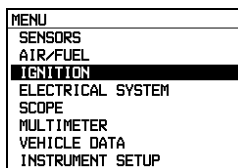

Press (SELECT) to confirm your selection (IGNITION).

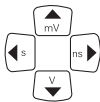

Use the arrow keys to highlight SECONDARY.

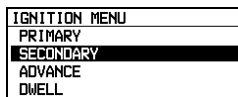

Press (SELECT) to confirm your selection (SECONDARY ignition test is activated).

Connection Help

A message on the display asks you to connect the Secondary Pickup to INPUT A and around the Spark Plug Wire. The test tool's COM input must be connected to the engine ground.

For this measurement we use the red test lead, since the Demo Board is not able to generate a high voltage secondary signal. Connect the red test lead to INPUT A, the red alligator clip to TP 2 (SEC. IGN.), and the black alligator clip to the GND connection of the Demo board.



Press (OK) to confirm your connection.

Result

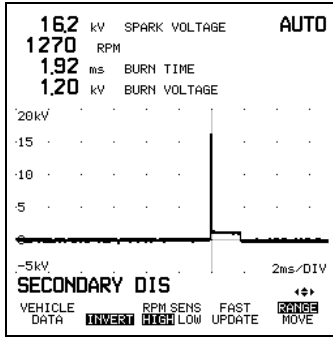

The Next Step

RECORD

Press to display the Record selection menu.

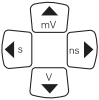

Use the arrow keys to highlight INTERMITTENT RECORD.

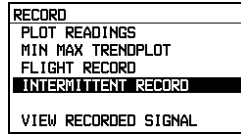

F5

Press (SELECT) to confirm your selection (INTERMITTENT RECORD is activated).

If there is previous record data in memory, a message will appear on the display.

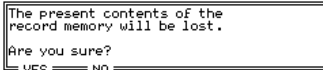

If you press **F1** (YES) recording starts.

If you press **F2** (NO) recording is cancelled.

Do

To stop the Recording, press any key.

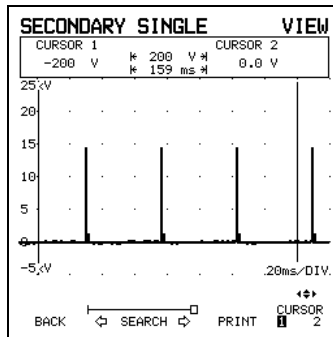

Press **F2** and **F3** to step back and forth through the recorded screens.

Press **F1** to return to the normal test mode.

RECORD FLIGHT RECORD

The test tool's FLIGHT RECORD function records up to 40 successive screens that have been displayed from start recording.

Exercise

Record the simulated ignition signal from the Demo Board (still connected from the previous exercise) with the FLIGHT RECORD function.

Steps



Press the RECORD key to open the selection Menu.

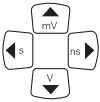

Use the arrow keys to highlight FLIGHT RECORD.

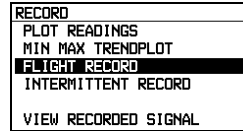

Press (SELECT) to confirm your selection (FLIGHT RECORD is activated.).

If there is previous record data in memory, a message will appear on the display.

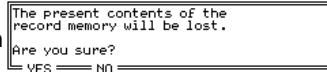

If you press **F1** (YES), recording starts.

If you press **F2** (NO), recording is cancelled.

Do

Change RPM by turning the RPM potentiometer for a few seconds. To stop the recording, press any key.

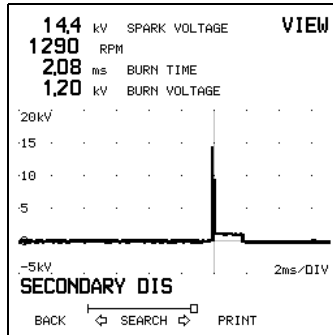

Press **F2** and **F3** to step back and forth through the recorded screens.

SAVE/RECALL OF SCREENS

The test tool can store and recall screens and instrument setups instantly.

Exercise

Save the Hall-Effect sensor output signal and recall it.

Steps

Connect the test tool to display the simulated Hall-Effect sensor signal (Refer to General Sensors test on page 2-13 for menu selection and connection information).

The test tool automatically scales and displays the waveform on the screen.

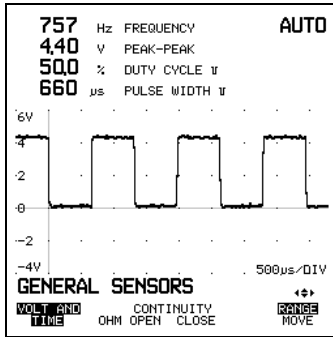

The Next Step



Press to freeze the signal on the screen. HOLD is displayed on the top right.

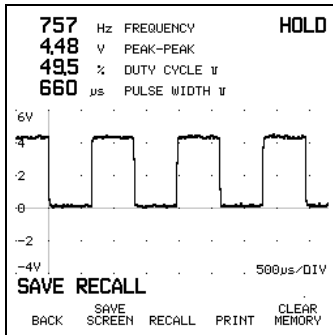

Do

F2

Press (SAVE SCREEN) to save the current screen into memory.

F1

Press (OK) to confirm the saving of the signal in the memory.

F1

Disconnect the signal and press F1 (Back). The signal will disappear from the screen.

SAVE
RECALL

Press to display the SAVE RECALL menu.

F3

Press to recall the stored sensor signal.

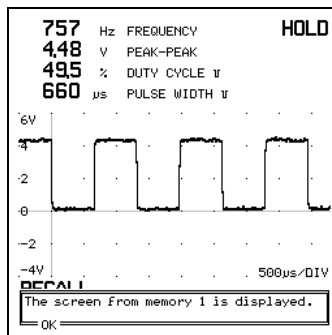

F1

Press to recall the displayed screen.

NOTE:

If more than one screen has been saved in memory, F2 + F3 will allow scrolling between stored screens.

CURSOR KEY FUNCTION

The test tool can measure signal details by using Cursors.

Exercise

Use the cursor(s) to measure the positive pulse width.

Steps

Display the GEN.SENSOR signal on the screen (Refer to General Sensor Test on page 2-13)

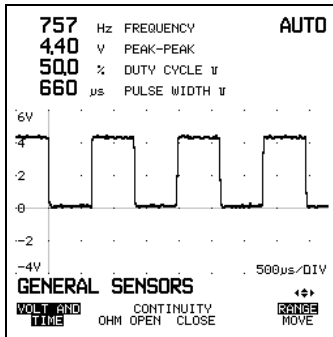

The Next Step



Press to display the CURSORS function key menu.

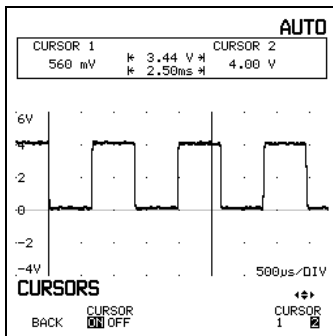

Do

Press to turn the cursors on or off (leave cursors on).



Press to select the cursor to move.

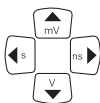

Use the arrow keys to position the cursors as shown in the following screen.

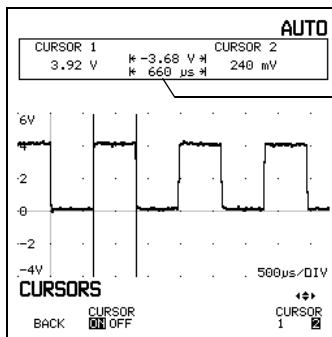

Time difference
between the cursors

Cursor 1 is placed on the rising edge of the positive pulse, and cursor 2 on the falling edge.

The lower reading in the center of the top display indicates the time difference between the cursors, which is the width of the positive pulse (660 μ s).

Chapter 3

Using the Automotive ScopeMeter Test Tool

INTRODUCTION	3-3
Probes and Test Leads	3-3
Preparations for Automotive Measurements	3-7
MENU OVERVIEW	3-8
Navigating the Menu	3-9
Using the Function Keys	3-10
Examples of Function Key Labels	3-10
Reading Test Results on the Display	3-11
USING SENSOR FUNCTIONS	3-13
General Sensors	3-13
Oxygen Sensor	3-15
Dual Oxygen Sensor	3-16
Temperature Sensor	3-17
Knock Sensor	3-18
Potentiometer	3-19
USING AIR/FUEL FUNCTIONS	3-20
Fuel Injector	3-20
Potentiometer	3-21
Stepper Motor	3-21
Oxygen Sensor	3-22
Dual Oxygen Sensor	3-22
General Sensors	3-22
USING IGNITION FUNCTIONS	3-23
Primary	3-23
Secondary	3-25
Advance	3-26
Dwell	3-27
USING DIESEL FUNCTIONS	3-28
Diesel injector	3-28
Advance (Diesel)	3-29

- USING ELECTRICAL SYSTEM FUNCTIONS** 3-30
 - Charging 3-31
 - Battery Test 3-32
 - Potentiometer 3-33
 - Solenoid and Diode 3-34
 - Voltage Drop 3-35
 - Stepper Motor 3-36

- USING SCOPE FUNCTIONS** 3-37
 - When Using the Scope 3-37
 - Using Single and Dual Input Scope 3-38
 - Making an Easy Setup 3-39
 - INPUT A Control Functions 3-40
 - INPUT B Control Functions 3-41
 - Single-Shot Function 3-42
 - Trigger Control Functions 3-43
 - Testing Relative Compression 3-45

- USING MULTIMETER FUNCTIONS** 3-47
 - Making Connections 3-47
 - Testing Volt DC, AC 3-48
 - Testing Resistance, Continuity, and Diode 3-49
 - Measuring RPM 3-51
 - Testing Frequency, Duty Cycle, or Pulse Width 3-52
 - Testing Current 3-54
 - Testing Temperature 3-55

- CHANGING THE VEHICLE DATA AND INSTRUMENT SETUP** .. 3-56
 - Setup Overview 3-56
 - Changing Vehicle Data 3-57
 - Changing Instrument Setup 3-58
 - Changing Test Lead Setup 3-62

INTRODUCTION

This section provides general information for automotive measurements with the test tool.

Probes and Test Leads

The test tool displays information about the type of probe to use (referred to as Connection Help) before you enter a new test. In addition, Chapter 5 'Automotive Applications' depicts the required connections and the use of probes, test leads, and adapters for each application.

Overview of the Standard Set of Probes, Test Leads, and Test Lead Adapters

STL 90 Shielded Test Leads

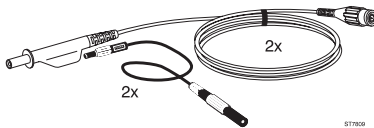

Red and grey, with ground leads.
For general purpose use (1:1).
Connected to BNC inputs (red INPUT A and grey INPUT B.)

BNC Extension Leads

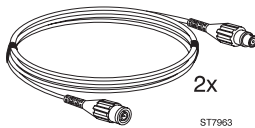

Two pieces, black.
Used for the extension of the Shielded Test Leads.

PM9096/101 Secondary Pickup (Europe only)

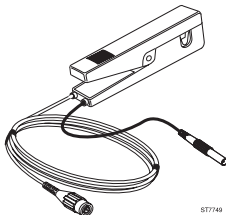

Used for secondary ignition tests.
Connected to INPUT A.

CAP 90 Secondary Pickup with HEI plates

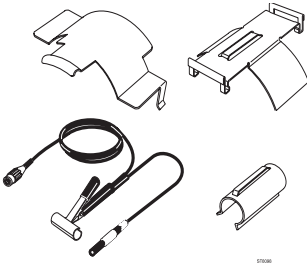

Used for secondary ignition tests. Ground lead connected to engine ground.

RPM 90 Inductive Pickup

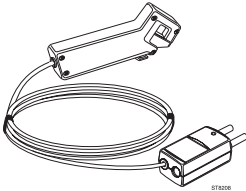

Used as trigger synchronization for conventional ignition systems (with distributor) and for RPM measurements on spark leads. Connected to COM and TRIGGER inputs.

Ground Lead (black).

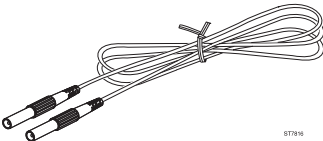

Used to connect the test tool COM input to the engine ground. This is necessary for safety reasons on all IGNITION tests. The ground lead has 4-mm shrouded banana plugs at each end.

Ground Lead Extension (black).

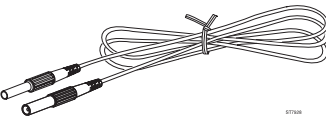

The ground lead extension has a 4-mm banana jack at one end and a 4-mm banana plug at the other end.

Filter Adapter.

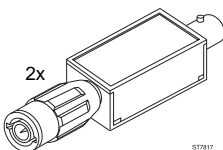

Used for oxygen sensor tests to provide 10 MΩ/3.5pF input impedance. This low-pass Filter Adapter eliminates noise over 4 kHz. One side of the adapter is connected to INPUT A or B, the other side is used to connect the shielded test lead.

4-mm Banana Adapters

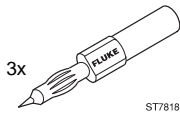

ST7818

Three pieces, red, grey, and black.

You can plug the 4-mm banana adapter on the tip of the shielded test lead for use as a (exposed) test tip, or for connection to 4-mm breakout box jacks.

2-mm Adapters

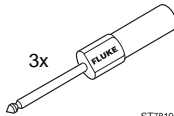

ST7819

Three pieces, red, grey, and black.

You can plug the 2-mm adapter onto the tip of the shielded test lead to enable access to narrow contacts (2-mm or wider) or to connect to 2-mm breakout box jacks.

Back Probe Pins

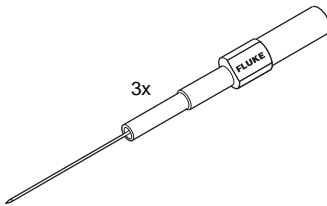

ST7820

Three pieces, red, grey, and black.

You can plug the spring loaded back probe pins onto the tip of the shielded test lead to enable access between the wire and weather pack seal. Contact is made on the shielded connector

Alligator Clips

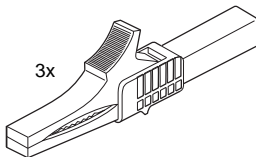

ST7918

Three pieces, red, grey, and black.

You can plug the clips onto the tip of the shielded test lead or ground lead for test or ground terminals.

Overview of Optional Probes and Probe Accessories

90i-610s Current Probe

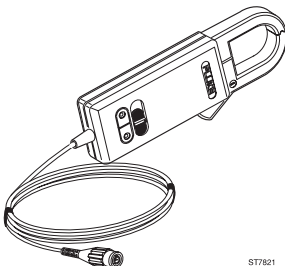

ST7821

Used for all tests where current is measured.

These tests have the function key labels "AMP" and "CURRENT PROBE".

TR90 Temperature Probe

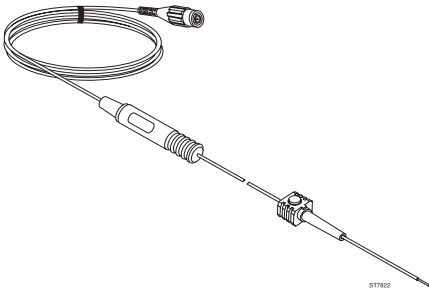

Used for oil, surface, air and coolant temperature measurement in °C or °F. This probe fits in the vehicle oil dipstick hole. The probe has an adjustable slider so you can adjust the length to that of the oil dipstick.

DPS90 Diesel Probe Set

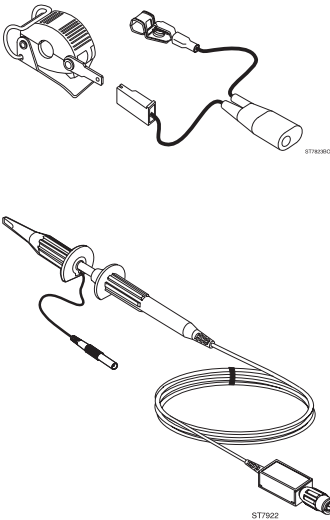

Used for RPM, injection pattern analysis, and advance tests on diesel engines with 6 mm fuel pipes. This set consists of a Piezo Pickup, which is clamped on the fuel pipe, a Probe-to-Piezo Pickup Adapter, a Low Pass Filter Probe to be connected to the test tool, and some additional accessories (not shown). Also see Appendix 7B under 'Optional Accessories'.

DPE90 Diesel Extension Set

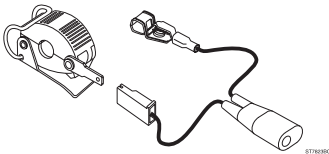

This set includes a diesel pickup clamp for 4.55 mm fuel pipe.

Preparations for Automotive Measurements

Do the following before you start automotive measurements:

- Follow the Safety Precautions as stated in the front of this manual.
- Prepare the car to be tested for the desired measurement, e.g. warm up the engine. In Chapter 5 "Automotive Applications" you can find the conditions required for each application.
- Make sure that the test tool settings correspond with the data of the vehicle to be tested. To verify this, look at the display when you switch the power on. The display shows VEHICLE DATA MENU with a list of settings that must correspond with the vehicle to be tested. (Also see the section "Changing Vehicle Data" on page 3-57)
- If you use other probes or test leads than those supplied with the test tool, you may have to change the setup for probes and test leads. (See "Changing Test Lead Setup" on page 3-62)
- Select the desired test from the menu. The 'Online Help' information displayed above the menu can help you make the right choice from the menu.
- Before the test starts, a message is displayed indicating the probes or test leads to use and how to connect them, (see Figure 3.2). Use the correct probe(s) or test leads and connect them to the correct input on the test tool and to the vehicle to be tested. Chapter 5 gives you additional application information.

VEHICLE DATA MENU

```

CYLINDERS : 4
CYCLES    : 4
BATTERY   : 12V
IGNITION  : CONV
  
```

Figure 3-1. Display at Power-On.

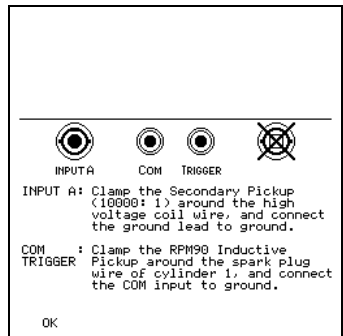

Figure 3-2. Connection Help.

MENU OVERVIEW

Figure 3.3 shows an overview of available test functions from the MENU key. The menu choices represent categories of applications that are listed in sub-menus as shown in the following figure.

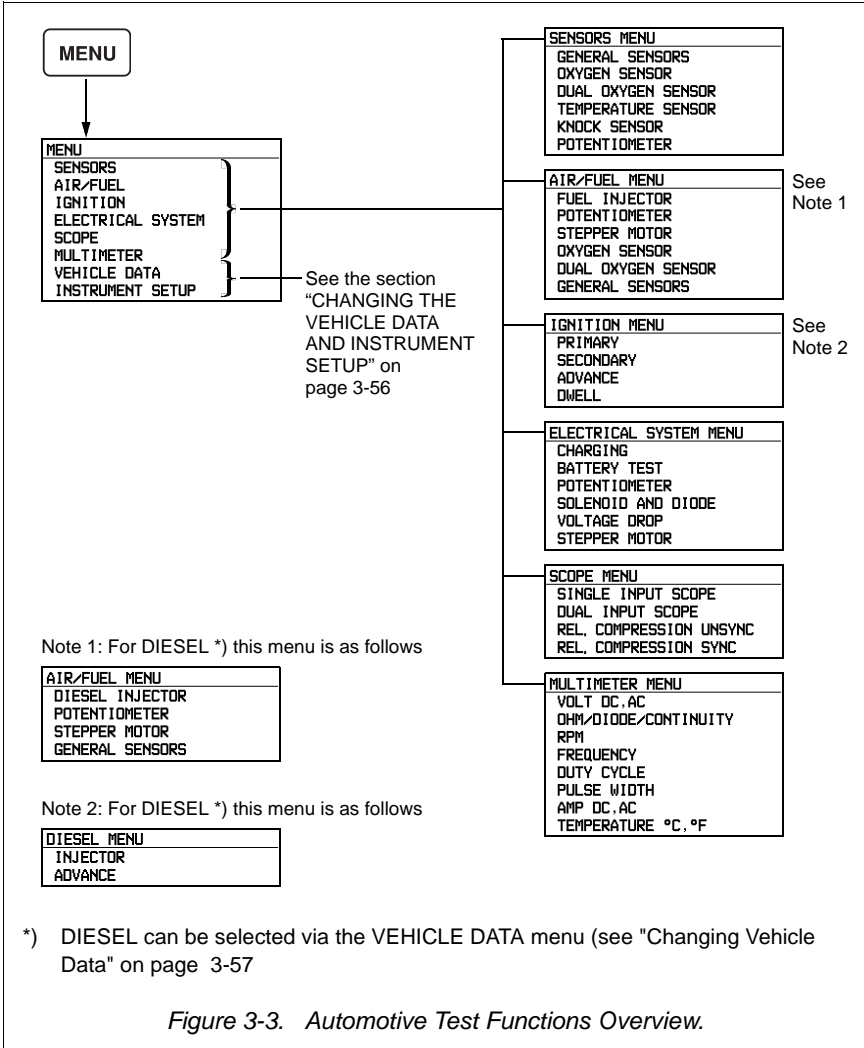

Figure 3-3. Automotive Test Functions Overview.

Navigating the Menu

The navigation sequence is similar for all tests. Therefore the following navigation example, which shows how to select the secondary ignition test, can help you learn navigate a menu. Perform the following sequence step by step.









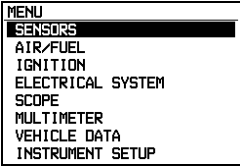

STEP NUMBER	KEY PRESS	DESCRIPTION	DISPLAY
①		Press to display the menu	
②	 	Press to move the highlight to IGNITION	
③	SELECT 	Press to select IGNITION MENU	
④	 	Press to move the highlight to SECONDARY	
⑤	SELECT 	Select SECONDARY from the IGNITION MENU.	
⑥	OK 	If you were performing an actual ignition test, the connection information would help you make the connections.	

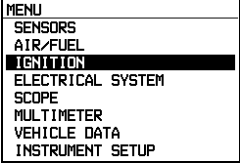
Figure 3-4. Connection Help Screen

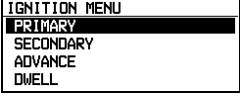
However, for this example, it is not necessary to make the connections shown. Press F1 (OK) to actually enter the test.

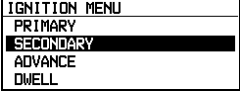
The bottom display shows the Function Key Labels for the SECONDARY IGNITION test function.

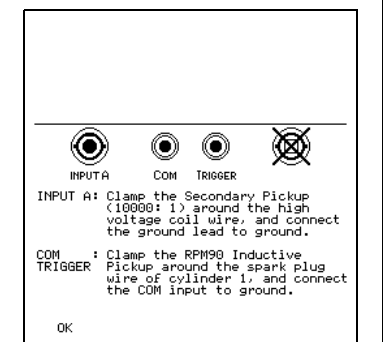
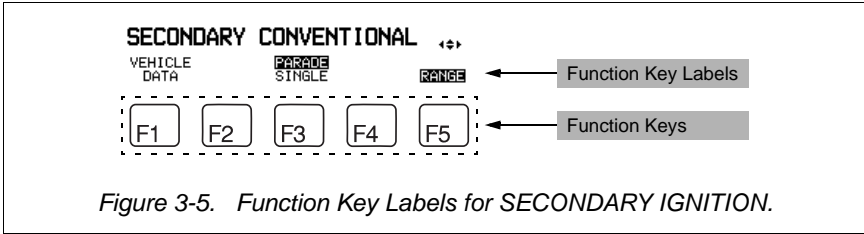

Figure 3-5. Function Key Labels for SECONDARY IGNITION.

Using the Function Keys

The labels displayed on the bottom display above the function keys F1 to F5, indicate what the keys do when you press them. (See the example in Figure 3.5 above.)

For each test, one or more Function Key Labels are displayed, depending on the sub-selections possible.

Pressing a function key that has no label (blank area on the display) has no effect.

The same Function Key Label can appear in several tests. In each case, it performs a similar function.

Examples of Function Key Labels

The following is an example of two separate functions on the same function key. The highlighted function is the active one. You can use the function key to toggle between the functions.

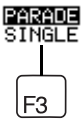

This is the F3 Function Key Label for SECONDARY IGNITION. See Figure 3.5. When you press **F3**, you can select between PARADE and SINGLE cylinder test.

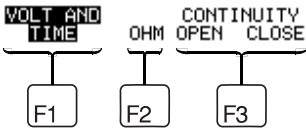

VOLT AND TIME is the active (highlighted) function.

When you press **F2**, OHM becomes the active function. When you press **F3**, CONTINUITY becomes the active function. The meaning of some general function key labels are described below.

Pressing **F3** a second time will toggle between OPEN and CLOSE.



The  icon indicates that you can use the arrow keys to change the measurement range (if RANGE is highlighted) or move the waveform position (if MOVE is highlighted). Press the function key to toggle between RANGE and MOVE.

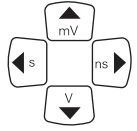

The  icon indicates that you can use the arrow keys to move CURSOR 1 (if 1 is highlighted) or move CURSOR 2 (if 2 is highlighted). Press the function key to toggle between CURSOR 1 and 2.

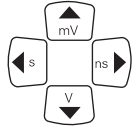

REPEAT
TEST

This label is displayed for tests that perform single measurements, for example the knock sensor and the potentiometer sweep test. To repeat the test, press the function key, then perform the required action. For example, the knock sensor test, tap the engine block for activation.

SET
ZERO

When you press the related function key, the present reading is used as zero reference to (delta) measure change. For example, when the present reading is 100 mV at the time you press the function key, all following readings display the difference from 100 mV. For example, 5 mV is displayed when the actual reading would be 105 mV. The present reading is replaced by a new zero reference value.

Reading Test Results on the Display

Measurement results can be displayed as numeric values (referred to as readings) and waveform. The types of readings depend on the test taking place. For example, during a GENERAL SENSORS test, PEAK-PEAK, FREQUENCY, DUTY CYCLE, and PULSE WIDTH are displayed as readings (see Figure 3-6.). The values you see on the display most often depend on the vehicle under test. Refer to the Service Manual of the vehicle manufacturer. In Chapter 5 "Automotive Applications" you can find typical results of certain applications.

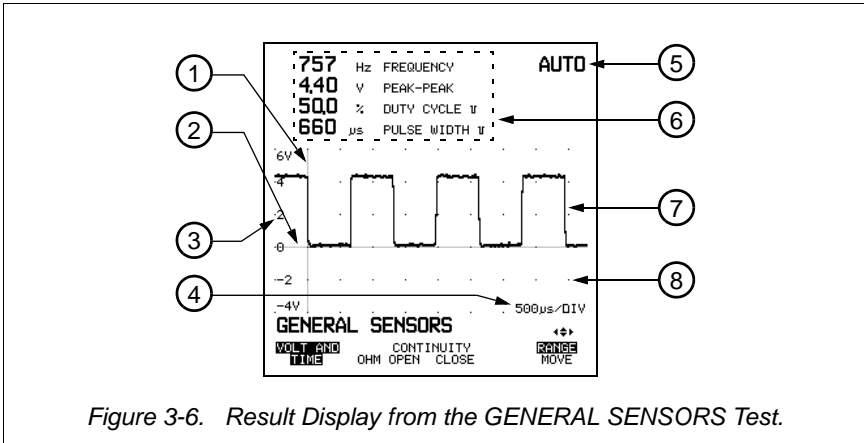



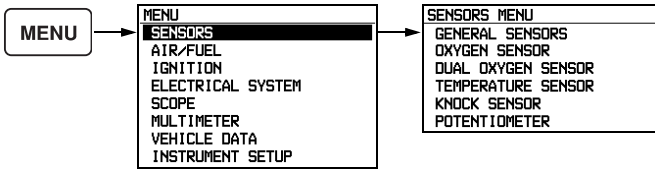

Figure 3-6. Result Display from the GENERAL SENSORS Test.

- ① Zero line for the horizontal timebase. This point in time represents the trigger event.
- ② Zero line for vertical signal amplitude (0V line.)
- ③  Vertical range (2V per division). You can change this with the up/down arrow keys. Notice when you do so that automatic ranging is turned off. See ⑤. Press  to reactivate automatic ranging.
- ④  Horizontal timebase range (500 μs per division). You can change this with the left/right arrow keys. Notice when you do so that automatic ranging is turned off. See ⑤. Press  to reactivate automatic ranging.
- ⑤ AUTOMATIC ranging is on for both horizontal timebase (see ④) and vertical range (see ③).
- ⑥ Readings calculated from the signal. The F1 Function Key Label indicates that a VOLT and TIME measurement is active. So the following readings represent either a voltage or a timing value.
- ⑦ Signal waveform.
- ⑧ Graticule. Graticules mark the horizontal and vertical divisions.

USING SENSOR FUNCTIONS



General Sensors

This menu option is used to test a variety of sensors. The test is done with the shielded test lead on INPUT A.



Function Keys and Result Screens

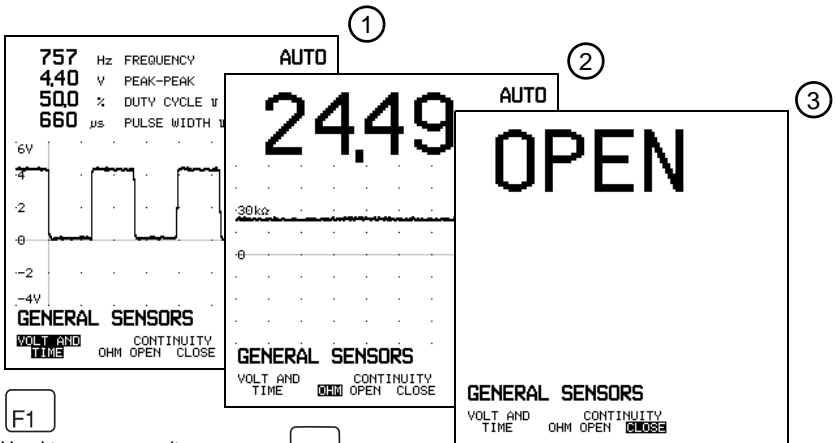

F1

Used to measure volt and time values of the signal

F2

Used to measure resistance

F3

Used to test whether a connection is open or closed. If you select OPEN, the test tool beeps when the tested connection is open. If you select CLOSE, it beeps when the tested connection is closed.

① This screen displays volt and time values of the signal.

PEAK-PEAK Indicates the difference in voltage between the lowest and highest value of the displayed waveform.

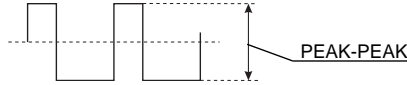

FREQUENCY Indicates the number of signal periods (waveform repetitions) per second.

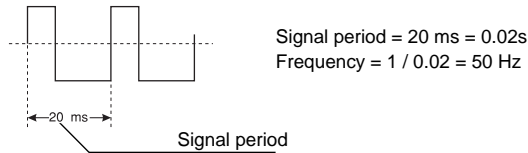

DUTY CYCLE  Indicates the ratio between the negative part of the signal and its period time expressed as a percentage.

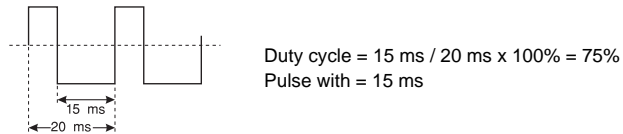



PULSE WIDTH  Indicates the width of the negative part of the signal.

② This screen displays the measured resistance in ohms (Ω).

OL This is displayed when the resistance is outside the test tool's measurement range. This occurs when the resistance of the sensor is too high or the connection to the sensor is interrupted or open.

③ This screen displays the continuity of a connection as follows:

OPEN  If the connection is open.

CLOSE  If the connection is closed.

Oxygen Sensor

This menu option is used to test an oxygen sensor also called O₂ sensor or Lambda sensor. The test is done with the shielded test lead connected via the Filter Adapter on INPUT A. The test tool automatically adapts for different types of sensors.

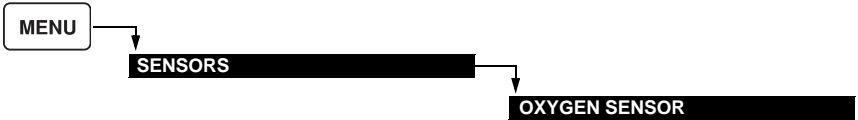

Result Screen

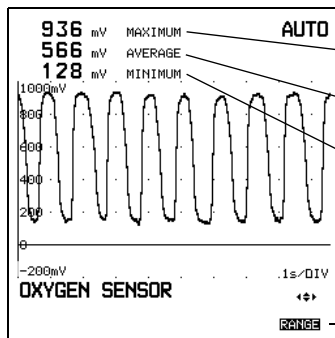

Maximum value of the displayed waveform.

Average value of the displayed waveform.

Minimum value of the displayed waveform.

Use the arrow keys for ranging.

Press **AUTO RANGE** to return to the default range.

Dual Oxygen Sensor

This menu option is used to test the efficiency of the catalytic converter by comparing the signals from the oxygen sensor before and after the converter. Both STL90 probes are used, each connected via a blue filter adapter on the test tool's input A and B. The red probe is connected to the leading sensor (the sensor before the catalytic converter) and the grey probe to the trailing sensor (the sensor after the catalytic converter).



Result Screen

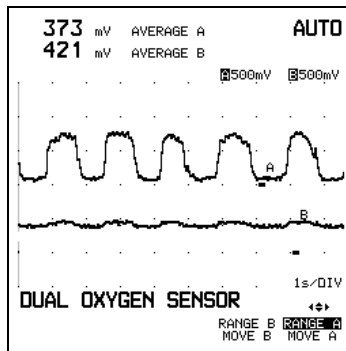

Temperature Sensor

This menu option tests the dc voltage or resistance from a temperature sensor. The test is done with the shielded test lead on INPUT A.

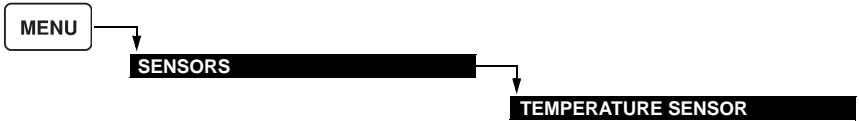

Function Keys and Result Screens

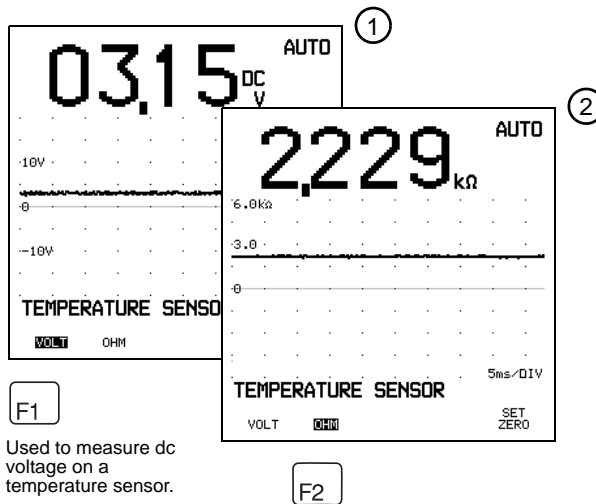

F1
Used to measure dc voltage on a temperature sensor.

F2
Used to measure the resistance of a temperature sensor (sensor disconnected).

- ① This screen displays the dc voltage from the temperature sensor. The waveform shows the dc voltage over time.
- ② This screen displays the measured resistance in ohms (Ω). The waveform shows the resistance over time.

Knock Sensor

The test is performed with the shielded test lead on INPUT A. After you enter the test, tap the engine block close to the sensor or the sensor itself with a mallet to get a signal from the knock sensor.



Function Keys and Result Screen

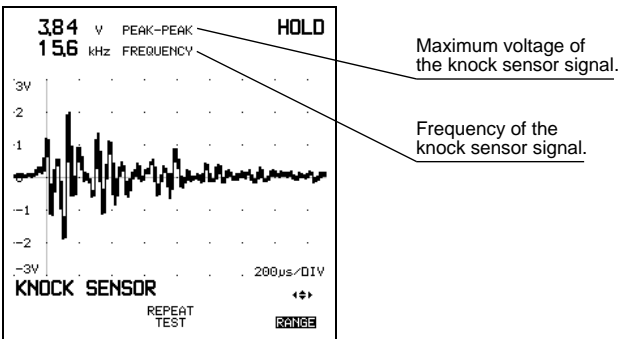

F3 Press this key to repeat the test.

The test is a single shot measurement, which means that the signal from the knock sensor is displayed only once. To get a new test result, you have to press the F3-key and then tap the engine block or the sensor again. You may have to readjust the vertical range with the arrow keys to get an optimal waveform.

Potentiometer

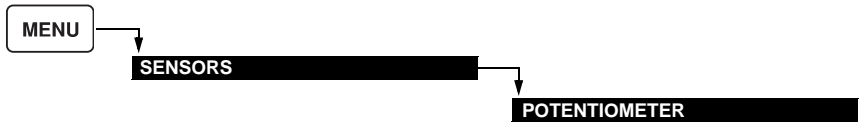

Use this menu option to test the voltage output of a potentiometer type sensor. The test is done with the shielded test lead on INPUT A.

Function Keys and Result Screen

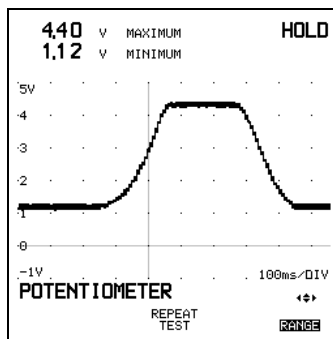

F3 Press this key.

This is a single-shot measurement, which means that the signal from the potentiometer is displayed once. Turn the potentiometer slider from full counter clockwise to full clockwise or from full clockwise to full counter clockwise to get result display. To get a new test result, you have to press the F3-key and then turn the potentiometer again.

On a throttle position sensor, open and close the throttle quickly.

This screen displays dc voltage on the potentiometer. The waveform shows the dc voltage while you turn the slider.

MAXIMUM This is the highest voltage measured on the waveform.
MINIMUM This is the lowest voltage measured on the waveform.

USING AIR/FUEL FUNCTIONS

This menu option is used to test actuators and sensors in the vehicles's air and fuel system.

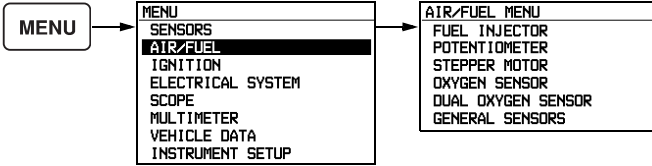

Fuel Injector

The test is done with the shielded test lead on INPUT A.



Result Screen

368 ms INJECTION PULSE
89.6 V MAXIMUM

100V
80
60
40
20
0
-20V

FUEL INJECTOR
VEHICLE DATA

2ms/DIV
RANGE MOVE

Duration of the injection pulse.

Maximum voltage of the induced peak.

Press to display the vehicle data menu. You can make changes to match the vehicle under test.

Press to select the arrow keys for ranging or moving the primary ignition signal.

F1 F2 F3 F4 F5

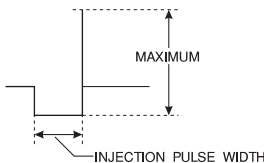

Potentiometer

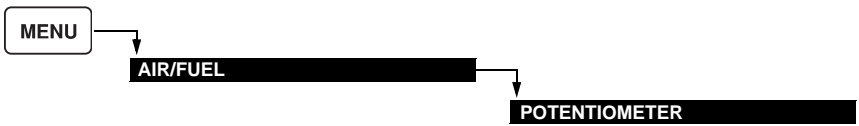

This menu option performs the same as POTENTIOMETER in the SENSORS MENU. Refer to the description of this menu option on page 3-19.

Stepper Motor

Use this menu option to test the voltage pulse that controls a stepper motor or to test the resistance of the stepper motor. The test is done with the shielded test lead on INPUT A.



Function Keys and Result Screens

1

Press to test the voltage pulse that controls the stepper motor.

Press this key to repeat the test.

Press this key to measure the resistance of the stepper motor (disconnected).

The image shows two screenshots of the Stepper Motor test results. The left screenshot displays a voltage pulse waveform with a reading of 15.6 V PEAK-PEAK. The right screenshot displays a resistance reading of 018.2 Ω. Both screenshots show the 'STEPPER MOTOR' menu options: VOLT, OHM, and REPEAT TEST. The right screenshot also shows the 'RANGE' option. The voltage test is a single shot measurement, while the resistance test is a continuous measurement.

For the voltage test (F1 key), this is a single shot measurement, which means that the signal is displayed only once. To get a new test result, press the F3-key and reapply the signal from the stepper motor.

- ① **PEAK PEAK** Indicates the difference in voltage between the lowest and the highest value of the displayed waveform.

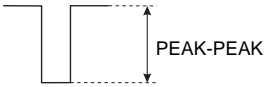

Oxygen Sensor



This menu option performs the same as OXYGEN SENSOR in the SENSORS MENU. Refer to the description of this menu option on page 3-15.

Dual Oxygen Sensor



This menu option performs the same as DUAL OXYGEN SENSOR in the SENSORS MENU. Refer to the description of this menu option on page 3-16.

General Sensors



This menu option performs the same as GENERAL SENSORS in the SENSORS MENU. Refer to the description of this menu option on page 3-13.

USING IGNITION FUNCTIONS

Use this menu option to test the vehicle's ignition system.

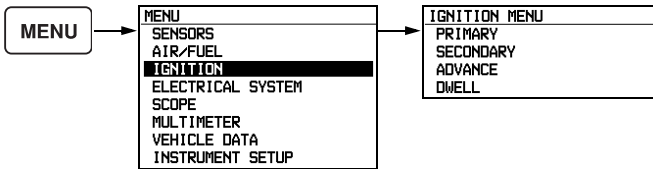

Primary

This test is done with the shielded test lead on INPUT A, connected to the primary side of the ignition system. In addition, for conventional systems, the Inductive Pickup connected on the COM/TRIGGER inputs, is clamped around the spark plug wire of the first cylinder, close to the spark plug.



Function Keys and Result Screen

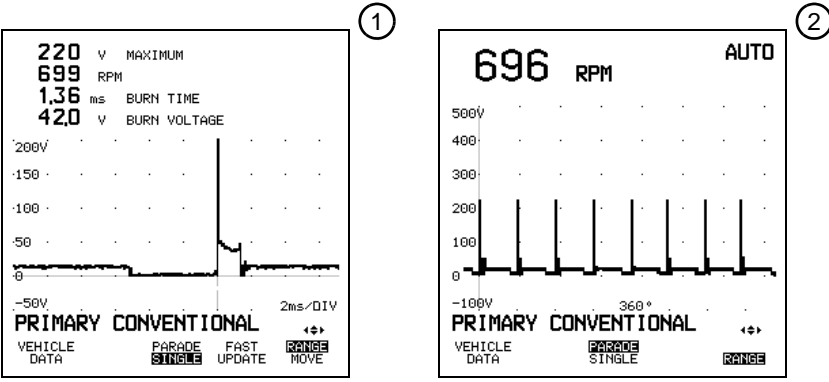

F1 F2 F3 F4

Press to select fast waveform updating with readings omitted (not for PARADE).

Press to select between single cylinder and parade test (conventional systems only).

- ① Single cylinder result screen.
- ② Parade result screen.

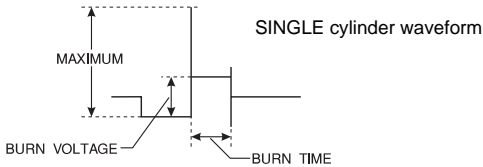

Secondary

This test is done with the Secondary Pickup connected to INPUT A and, for conventional systems, the Inductive Pickup connected to the COM/TRIGGER inputs. The Secondary Pickup is clamped around the high voltage coil wire. The RPM90 Inductive Pickup is clamped around the spark plug wire of the first cylinder.



Function Keys and Result Screens

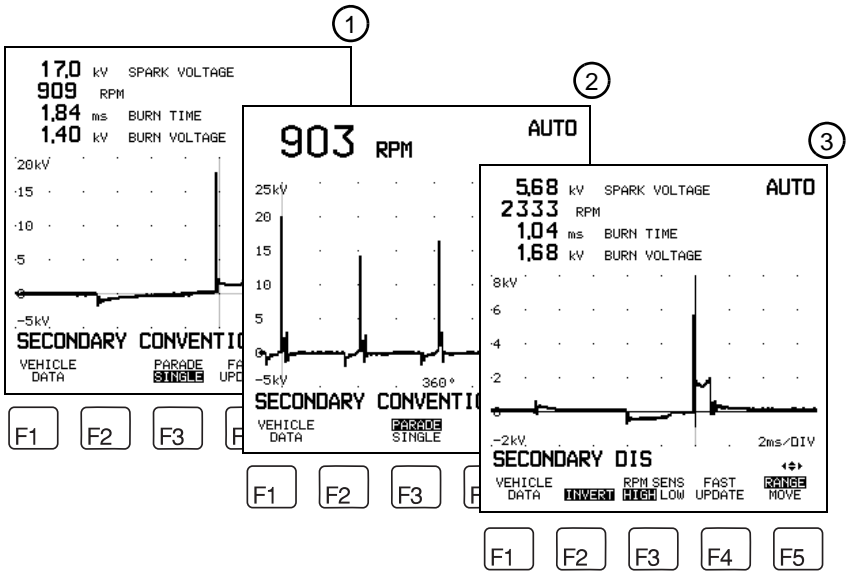

Press this key to invert the displayed ignition waveform.

Press this key to select the RPM SENSitivity level (see page 5-64 for more information).

- ① Single cylinder result screen (Conventional).
- ② Parade result screen (Conventional).
- ③ DIS result screen.

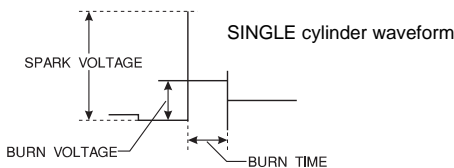

Advance

Use this menu option to test timing advance (TDC sensor required.) The test tool measures the time difference in degrees of crankshaft rotation, between ignition and the top dead center signal. The test is done with a shielded test lead on INPUT A, connected to the primary side of the ignition coil. For conventional systems, the Inductive Pickup, connected on the COM/TRIGGER inputs, is clamped around the spark plug wire of the first cylinder, close to the spark plug. In addition, a shielded test lead, connected on INPUT B, is connected to the TDC sensor signal. Do not connect the ground lead of this test lead (double grounding).



Function Keys and Result Screens

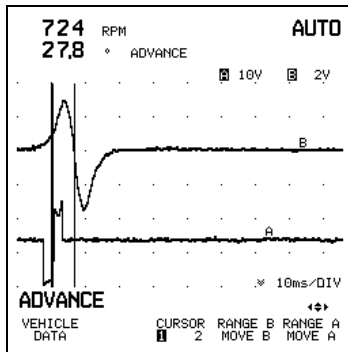

Press to select the arrow keys for moving CURSOR 1 or 2.

Press to select the arrow keys for ranging or moving the TDC sensor signal (on INPUT B).

Press to select the arrow keys for ranging or moving the primary ignition signal.

Place the cursors as indicated on the above screen.

Dwell

The test is done with the shielded test lead on INPUT A connected to the primary side of the ignition coil.

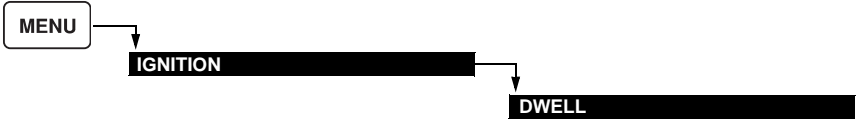

Function Keys and Result Screens

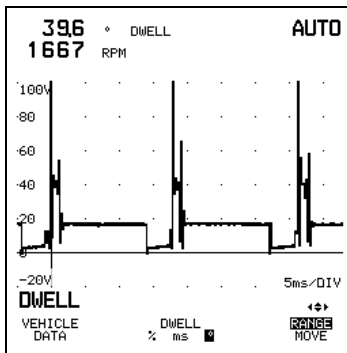

F1 F2 F3 F4 F5

Press to select between readings in %, degrees (°) crankshaft rotation, or in ms.

USING DIESEL FUNCTIONS

The diesel test functions are selected if 'IGNITION: DIESEL' has been set in the VEHICLE DATA menu. (See Changing Vehicle Data on page 3-57).

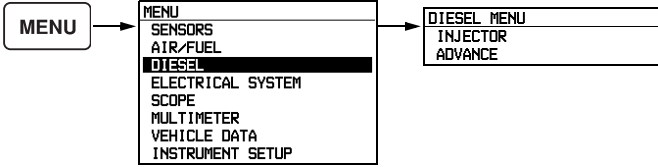

Diesel injector

Use this menu option to check injection pressure pulses on a diesel engine with use of the optional Diesel Probe.

The Diesel Probe should be clamped on a straight and clean part of the fuel pipe, close to the injector.

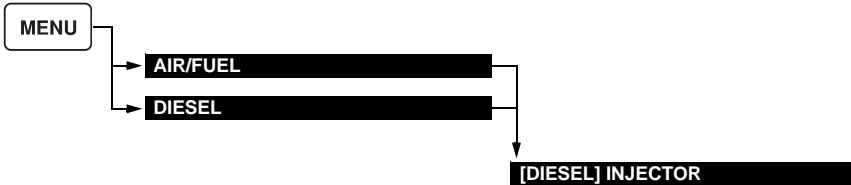

Result Screen

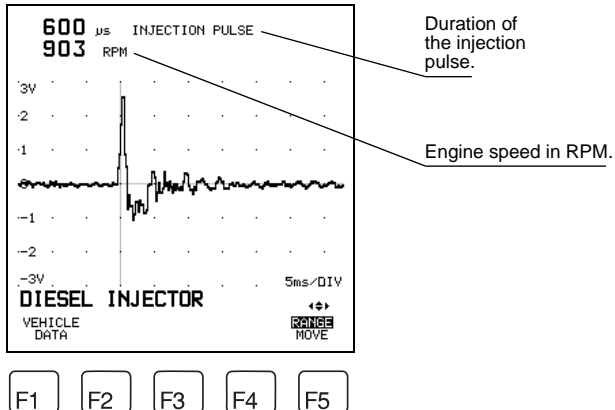

Advance (Diesel)

Use this menu option to test advance on a diesel engine vehicle (TDC sensor required.) The test is performed with the optional Diesel Probe clamped on a straight and clean part of the fuel pipe close to the injector and with the shielded test lead on INPUT B connected to the TDC sensor. Do not connect the ground lead of the INPUT B test lead (double grounding).



Function Keys and Result Screens

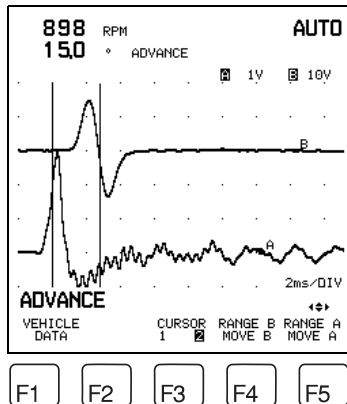

Place the cursors as indicated on the above screen.

USING ELECTRICAL SYSTEM FUNCTIONS

Use this menu option to test the electrical system of a vehicle.

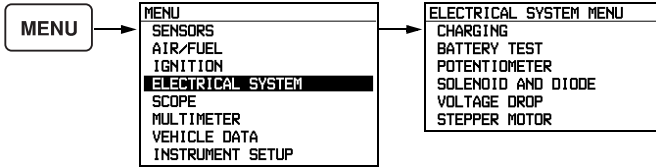

Charging

Use this menu option to test the charging system of a vehicle. This test is done with the shielded test lead on INPUT A to test voltage, or with the optional current probe to test current.

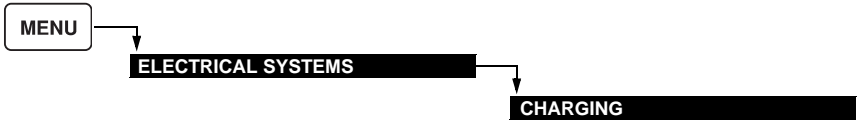

Function Keys and Result Screens

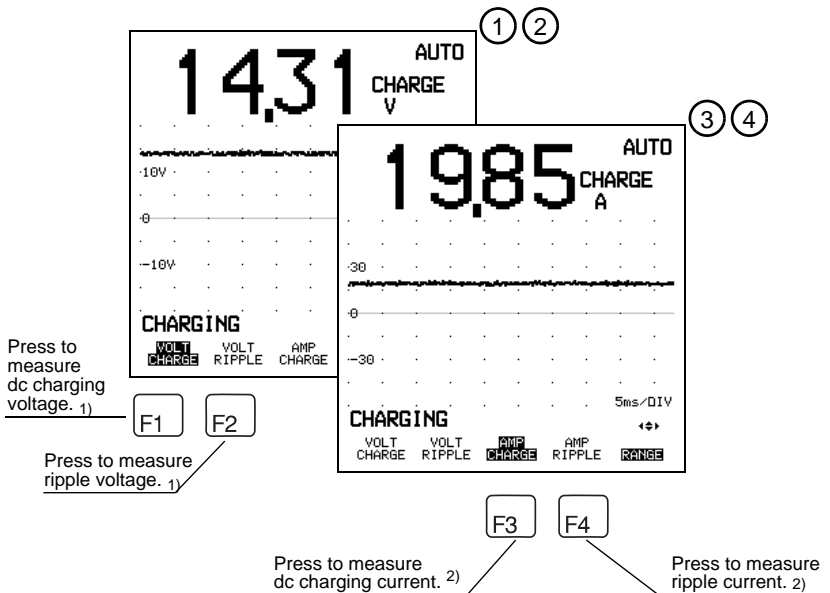

1) Use shielded test lead

2) Use current probe

- ① These screens display the dc voltage and the rms ripple voltage from the vehicle's alternator.
- ②
 - CHARGE Indicates the dc voltage output of the alternator.
 - RIPPLE Indicates the rms voltage of the ripple that rides on top of the alternator output voltage.
- ③ These screens display the dc current output from the alternator.
- ④
 - CHARGE Indicates the dc charging current.
 - RIPPLE Indicates the rms ripple current during battery charging.

Battery Test

Use this menu option to test the battery performance while cranking the engine. The test is done with the shielded test lead on INPUT A to test voltage or with the optional current probe to test current.



Function Keys and Result Screens

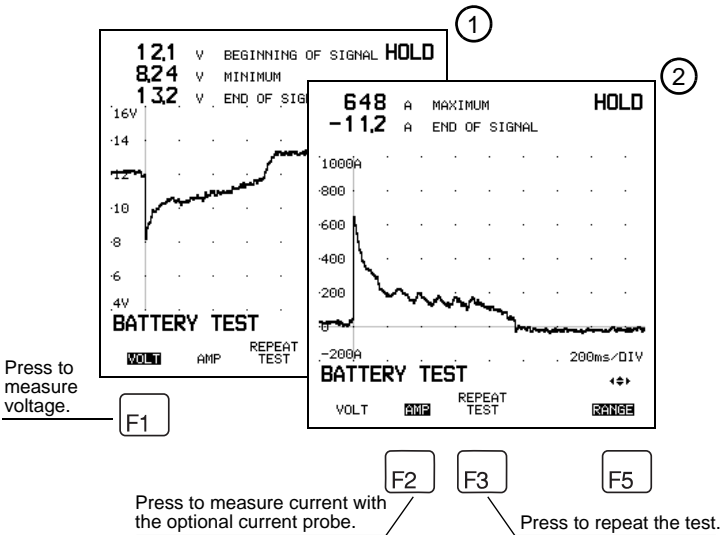

This test is a single shot measurement, which means that the signal is displayed only once. To get a new test result, stop the engine, press the F3-key and crank the engine again.

- ① This screen displays the battery voltage during cranking.

BEGINNING OF SIGNAL	Indicates the battery voltage at the beginning of the test.
MINIMUM	Indicates the minimum voltage during the test.
END OF SIGNAL	Indicates the battery voltage at the end of the test (charging voltage when engine runs).

- ② This screen displays the battery current output during cranking.

MAXIMUM	Indicates the maximum current during the test.
END OF SIGNAL	Indicates the battery current at the end of the test (charging current when engine runs).

Potentiometer

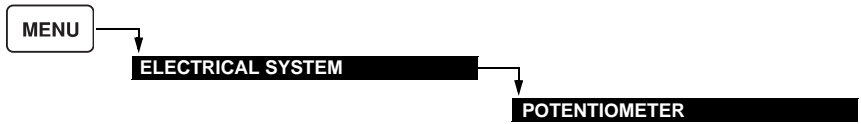

This menu option performs the same as POTENTIOMETER in the SENSORS MENU. Refer to the description of this menu option on page 3-19.

Solenoid and Diode

Use this menu option to test a solenoid and a clamping diode, which is connected across the solenoid. The clamping diode should minimize (clamp) the voltage spike due to the self-inductance of the solenoid when switching it off. The test is done with the shielded test lead on INPUT A.



Function Keys and Result Screens

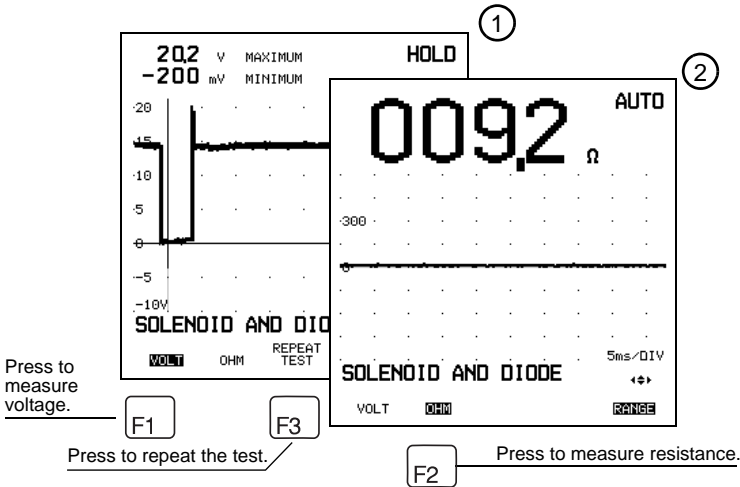

For the voltage test (F1 key), this is a single shot measurement, which means that the signal is displayed only once. To get a new test result, press the F3-key and reapply the signal from the solenoid.

- ① This screen displays the voltage across the solenoid.
 MAXIMUM Indicates the maximum voltage measured.
 MINIMUM Indicates the minimum voltage measured.
- ② This screen displays the resistance in ohms (Ω) measured across the solenoid.

Voltage Drop

Use this menu option to find high resistance or a loss of voltage across switches, wiring, and connectors. Loss of voltage (voltage drop) in wiring harnesses and connectors will cause poor performance of the connected device.

NOTE

A voltage drop occurs only when current flows through the wiring or connector. This test performs a "Min/Max TrendPlot" like test as described in Chapter 4. However, the result is not stored in memory. You can restart the test by pressing the F3 (REPEAT TEST) key.



Function Keys and Result Screen

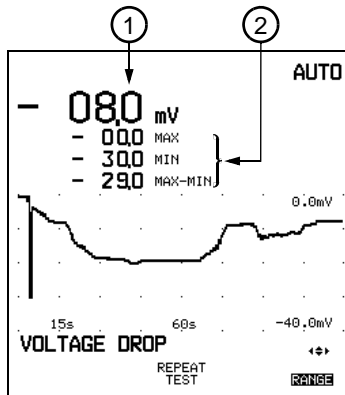

F3 Press to repeat the test.

- ① Indicates the actual voltage drop.
- ② MAX Indicates the maximum voltage drop during the test.
- MIN Indicates the minimum voltage drop during the test.
- MAX-MIN Indicates the difference between the maximum and minimum voltage drop during the test.

Stepper Motor



This menu option performs the same as STEPPER MOTOR in the AIR/FUEL MENU. Refer to the description of this menu option on page 3-21.

USING SCOPE FUNCTIONS

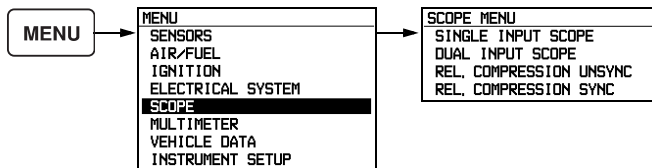

When Using the Scope

- Use the scope function if you want to simultaneously measure two waveforms - one on INPUT A and one on INPUT B (DUAL INPUT SCOPE.)
- RELATIVE COMPRESSION allows you to compare the compression of all cylinders.

Using Single and Dual Input Scope

Use SINGLE INPUT SCOPE if you want to use a single signal, INPUT B is turned off.

Use DUAL INPUT SCOPE if you want to simultaneously measure two signals.

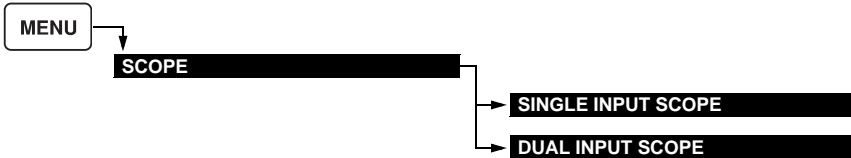

Function Keys and Result Screen

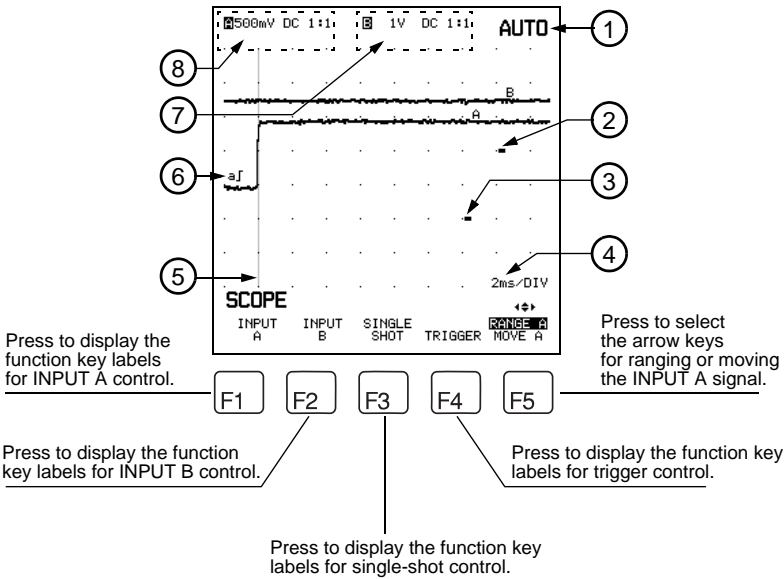

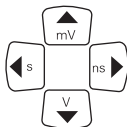

Figure 3-7. SCOPE display.

- ① Automatic ranging and signal tracking is on.
Pressing  sets automatic ranging and signal tracking on and off. If on, AUTO is displayed, if off, AUTO is extinguished.
- ② INPUT B zero level.
- ③ INPUT A zero level.
- ④ Timebase range.
- ⑤ Timebase zero line (trigger event.)
- ⑥ Trigger icon. Indicates the trigger source (a indicates INPUT A), the trigger slope ( indicates negative slope), and the trigger level (the vertical position of the icon.)
- ⑦ INPUT B range setting and probe identification. This label displays OFF when INPUT B is turned off.
- ⑧ INPUT A range setting and probe identification.

Making an Easy Setup

When you enter the scope function, the test tool automatically optimizes vertical range, timebase, and trigger settings, thus creating a stable display.



When you press one of the arrow keys, the test tool switches to manual control of range (timebase and vertical range) and trigger settings.



Press this key to toggle between automatic and manual control of range and trigger settings. Use this key if you cannot get a stable display using manual control.

INPUT A Control Functions

When you are in SINGLE or DUAL INPUT SCOPE, you can control the following INPUT A functions.

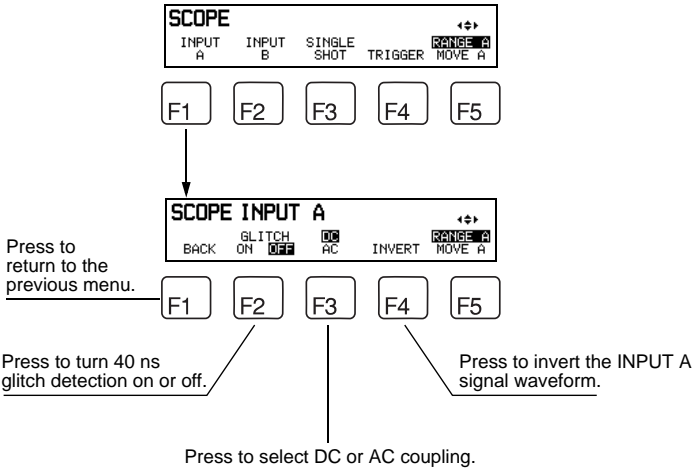

The GLITCH function enables you to capture and display events such as spikes that occur between two samples on INPUT A, which would otherwise not be visible. INPUT B is turned off when the GLITCH function is activated. The events can be glitches or other asynchronous waveforms that are 40 ns or wider. GLITCH detection is not possible in the DUAL INPUT SCOPE function.

DC Coupling allows you to measure and display both the DC and AC components of a signal. For example, you can measure and display battery charging voltage with AC ripple riding on top. AC coupling blocks the DC component and passes the AC component only. When you measure charging voltage with AC coupling on, you will only see the AC ripple voltage.

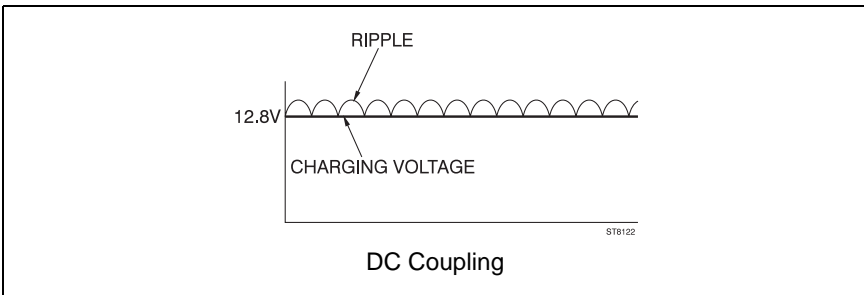

INPUT B Control Functions

When you are in SINGLE or DUAL INPUT SCOPE, you can control the INPUT B functions as follows.

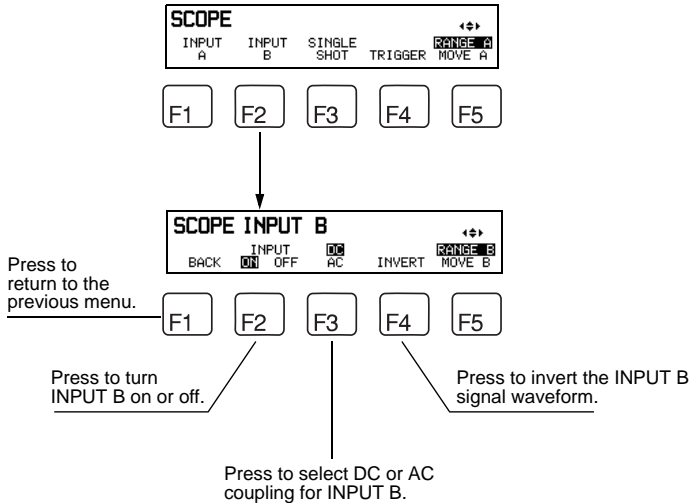

When you entered the scope function via the SINGLE INPUT SCOPE menu option, INPUT B is turned off by default, but you can turn it on by pressing F2. When INPUT B is turned on, GLITCH detection on INPUT A is turned off.

Single-Shot Function

Normally the scope function automatically repeats the measurements to acquire waveforms. This is called the recurrent acquisition mode.

SINGLE-SHOT allows you to perform single acquisitions to snap events that occur only once. REPEAT (F3) is used to start a next single acquisition.

When you are in SINGLE or DUAL INPUT SCOPE, you can perform single-shot measurements as follows.

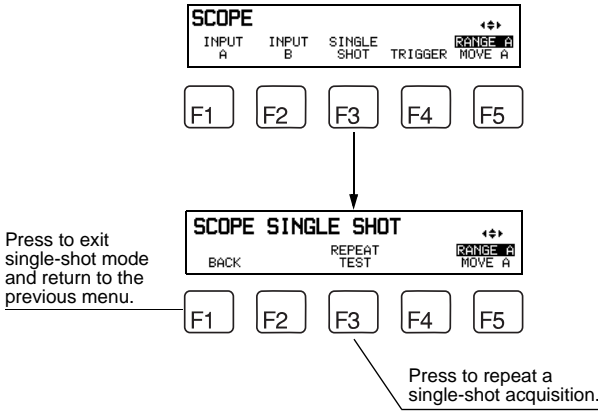

Trigger Control Functions

TRIGGER is a set of conditions that determine whether and when acquisitions start. The following will determine the trigger conditions:

- Select INPUT A, B, or TRIGGER as the TRIGGER SOURCE input.
- Use TRIGGERED or FREE RUNing acquisitions
- Select trigger to occur on a positive or negative SLOPE of the signal.
- SET the trigger LEVEL.

If you change the trigger level, the AUTO RANGE function is turned off, so that vertical and horizontal (timebase) ranging and trigger level are set to manual control. (Also see "Making an Easy Setup" on page 3-39.)

When you are in SINGLE or DUAL INPUT SCOPE, you can control the trigger functions as follows.

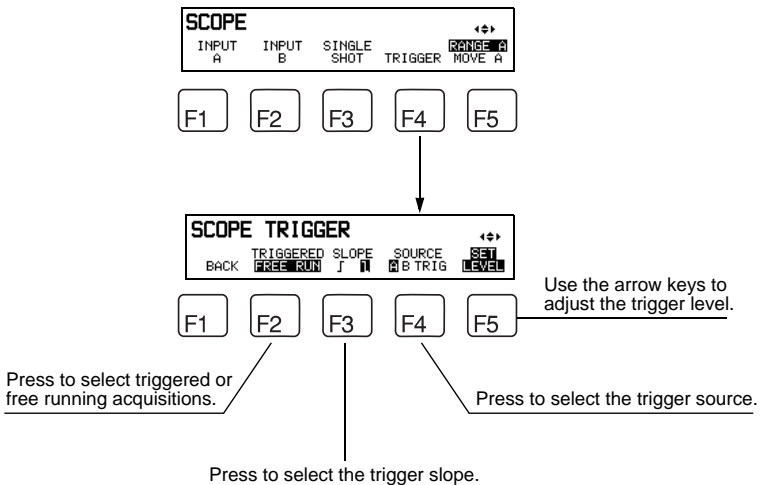

BTRIGGERED versus FREE RUNning acquisitions

If you select FREE RUN (default), the test tool always performs acquisitions, i.e., it always displays the signals on the input. If TRIGGERED is selected, a trigger is always needed to start an acquisition.

TRIGGER SLOPE

If you select , trigger occurs at a rising (positive) edge of the signal.

If you select , trigger occurs at a falling (negative) edge of the signal.

TRIGGER SOURCE

If you select TRIGGER SOURCE A (default), acquisitions start when the signal on INPUT A fulfills the selected trigger conditions (SLOPE, LEVEL).

If you select TRIGGER SOURCE B, the previous rule is valid for INPUT B (INPUT B must be ON.)



If you select TRIGGER SOURCE TRIG, the previous rule is valid for the signal on the TRIGGER input.

TRIGGER LEVEL (SET LEVEL)

This function allows you to set the level the signal must cross to trigger acquisitions.

Normally, after you enter the scope function, the AUTO RANGE function automatically sets and maintains an optimal trigger level as the signal changes.



Move the  trigger level icon (or  icon if trigger slope is set to negative) to the desired level.



NOTE

If you selected TRIG as the trigger source, you can select only 2V or 0.2V as trigger level.

Testing Relative Compression

This test is used to compare compression of cylinders during cranking. Engine start is disabled.

The principle of this test is based on battery voltage drop or current change during cranking.

Use unsynchronized (UNSYNC) RELATIVE COMPRESSION if you want to check if all cylinders have equal compression. From the compression graph on the display you cannot identify cylinder numbers, because there is no synchronization signal used for the test. In order to identify cylinder numbers, use synchronized (SYNC) RELATIVE COMPRESSION. Synchronization is done with the Inductive Pickup (RPM 90) on the spark plug wire close to the spark plug. Cylinder display is in firing order.

IMPORTANT

The relative Compression test can only be used on reciprocating piston engines. This test cannot be used on rotary (Wankel) engines. Also on odd fired engines, you may not be able to correctly interpret the results. Also see the Relative Compression application in Chapter5.

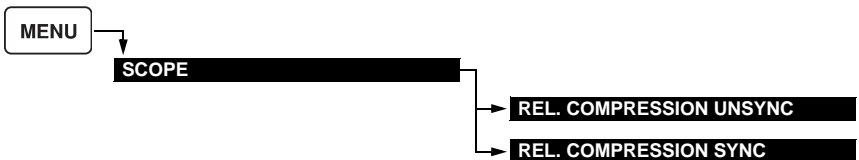

Function Keys and Result Screens

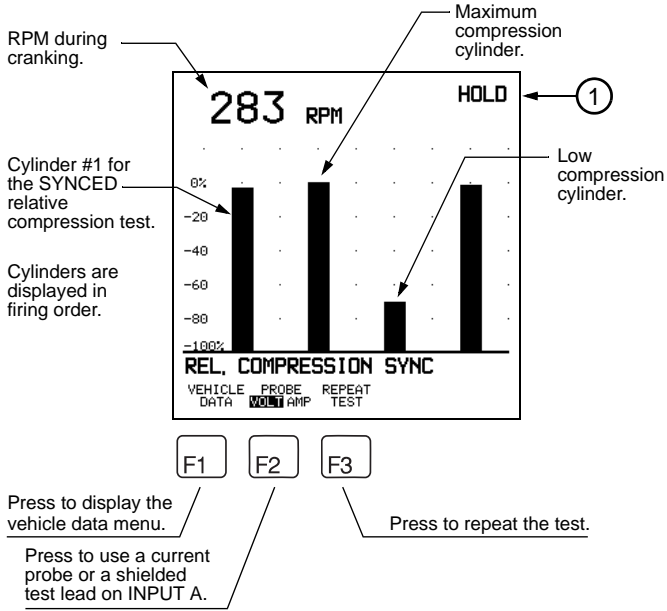

Figure 3-8. Relative Compression Test on a 4-Cylinder Engine.

- ① **WAIT** This is displayed in the following cases:
 - when you enter the test until the engine is cranked
 - when you press F3 (REPEAT TEST) until the engine is cranked.
- BUSY** This is displayed for about 6 seconds during cranking.
- HOLD** This is displayed when the test is completed. Then stop cranking.

If WAIT remains displayed, check the connections.

The peak value of the cylinder with the highest compression is displayed as the 0% reference. The peak values of the other cylinders are displayed relative to the 0% reference.

USING MULTIMETER FUNCTIONS

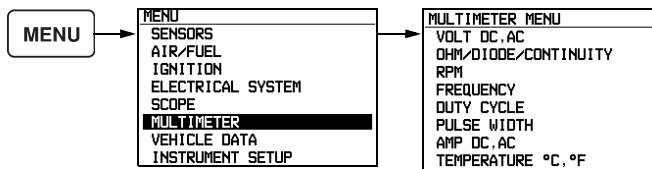

Making Connections

INPUT A is used for all MULTIMETER tests. The probes and test leads to be used depend on the type of test performed. When you select a MULTIMETER test, a connection help screen will guide you. This tells you which probe or test lead to use and where to connect it.

Testing Volt DC, AC

Use this menu option to test dc and ac voltages and ac+dc voltage.



Function Keys and Result Screen

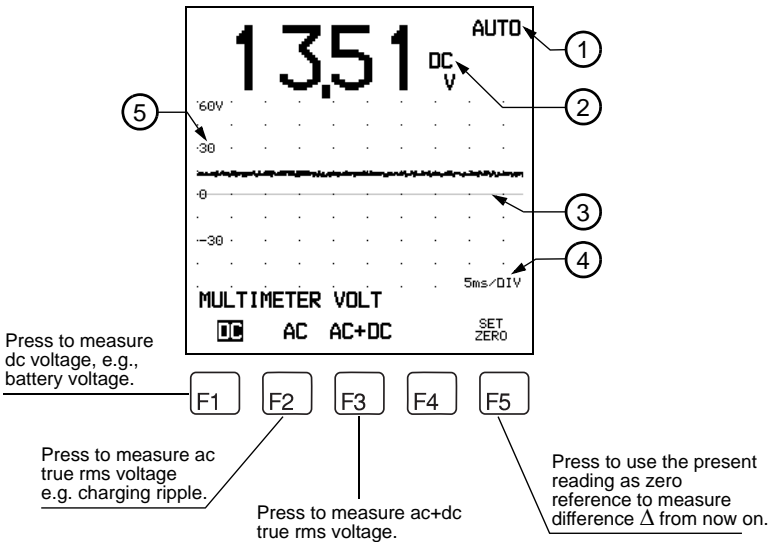



Figure 3-9. MULTIMETER VOLT display.

- ① **AUTO** indicates automatic ranging. Pressing  sets automatic ranging on and off. Using the arrow keys for ranging turns automatic ranging off and extinguishes **AUTO**.
- ② This indicates the dc, ac, or ac+dc reading, depending on which function (F1, F2, or F3) is active.
- ③ Voltage zero line (amplitude zero).
- ④ Timebase range (horizontal range: time per division).
- ⑤ Voltage range (vertical range: voltage per division).

Testing Resistance, Continuity, and Diode

Use this menu option to test resistance, diode forward voltage, and the continuity of wiring and connections. The test is done with the shielded test lead on INPUT A. Connect the test lead tip and test lead ground across the object (resistance, wire, diode, etc.) to be tested.



Function Keys and Result Screens

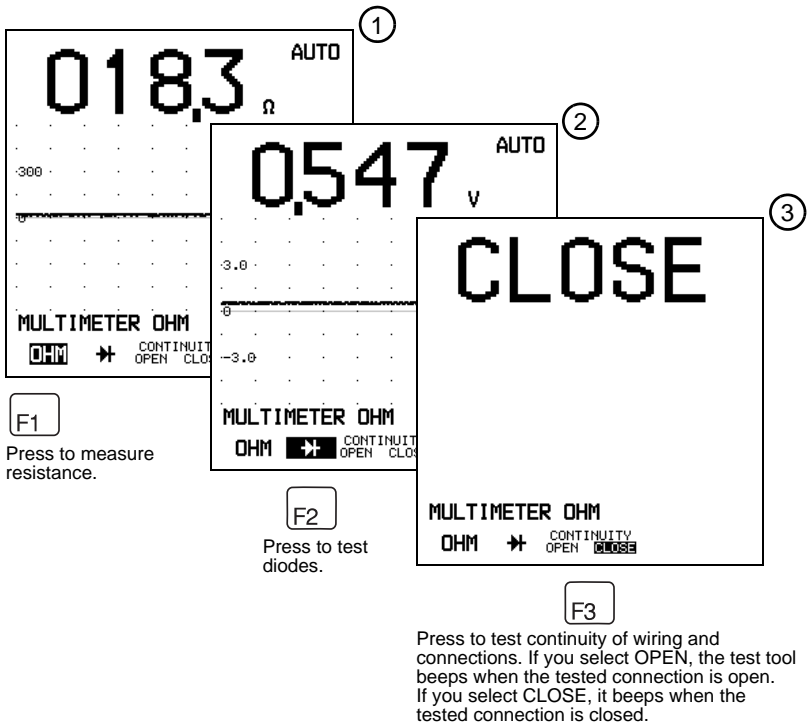

- ① This screen displays the measured resistance in ohms (Ω).

OL

This is displayed when the resistance is outside the test tool's maximum range. This occurs when the resistance of the sensor is too high or the connection to the sensor is interrupted or open.

- ② This screen displays the forward voltage across a diode. The test tool sends a small current through the diode to test the voltage across it. Depending on the type of diode, this voltage should be in the range from 300 to 600 mV. A diode that has an internal short will display about 0V.

OL

This is displayed when the diode is defective or when it is connected in reverse. See Figure 3-10 to verify the correct polarity of the connection.

If you are not certain about the polarity of the diode, try the reverse connection. If this also displays **OL**, the diode is defective. A good diode must display **OL** when connected in reverse.

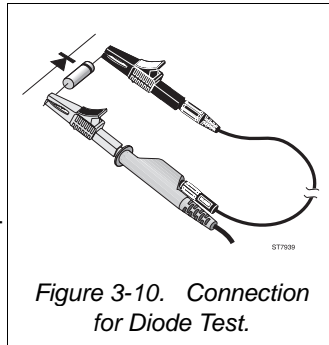

Figure 3-10. Connection for Diode Test.

- ③ This screen displays the continuity of a connection as follows:

OPEN



If the connection is open or interrupted.

CLOSE



If the connection is closed or shorted.

Measuring RPM

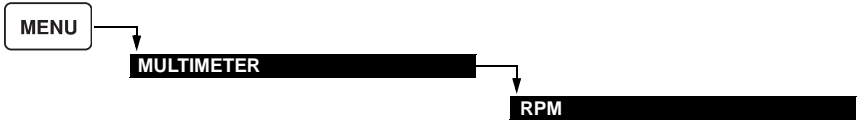

Function Keys and Result Screens

The screenshot shows the following information:

- Top display: **847 RPM**
- Top right: **AUTO**
- Waveform: Shows a series of pulses. A label points to it: "RPM signal waveform."
- Vertical axis: Labeled from -2 to 6V.
- Horizontal axis: Labeled "20ms/DIV".
- Bottom status bar:
 - TRIGGER: INPUT A
 - 1 (with up/down arrows)
 - 720 (with up/down arrows)
 - NORMAL
 - SET ZERO

Function key descriptions:

- F1:** Press to select the shielded test lead on INPUT A or the Inductive Pickup on the COM/TRIGGER input. This selection is not displayed for diesel.
- F2:** Press to decrease.
- F3:** Press to increase.
- F4:** Press to restore the default value settings stored in VEHICLE DATA.
- F5:** Press to use the presentRPM as zero reference to measure RPM change (Δ).

Additional note: These keys are used to set the number of test pulses to the test tool per 720° (two crank shaft revolutions)

NOTE:

You can use the arrow keys to change sensitivity and time base.

Testing Frequency, Duty Cycle, or Pulse Width

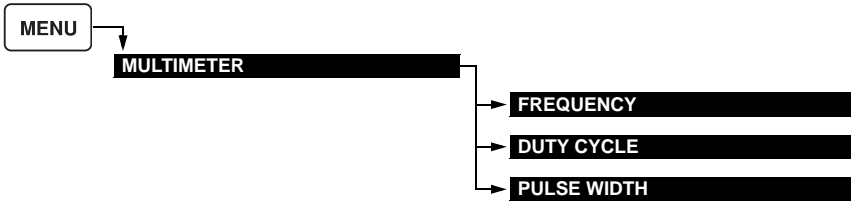

Function Keys and Result Screens

1

449.4 Hz AUTO

MULTIMETER FREQUENCY

F1

Press to test frequency.

2

050.0 % AUTO

MULTIMETER DUTY

F2

Press to test duty cycle. ¹⁾

3

01.11 ms AUTO

MULTIMETER PULSE WIDTH

F3

Press to test pulse width. ²⁾

- 1) You can also enter this test via DUTY CYCLE in MULTIMETER MENU.
- 2) You can also enter this test via PULSE WIDTH in MULTIMETER MENU.

For more details about the function key functions and the related result screens, see the following.

Hz





Press to test the signal frequency in Hz (screen ①).

DUTY CYCLE



Press to test the duty cycle of the signal (screen ②).

If you select , the duty cycle of the negative-going pulse is displayed.

If you select , the duty cycle of the positive-going pulse is displayed.

PULSE WIDTH



Press to test the pulse width of the signal (screen ③).

If you select , the width of the negative-going pulse is displayed.

If you select , the width of the positive-going pulse is displayed.

SET
ZERO

Press to use the present reading as zero reference (display Δ).

Testing Current

Test current with the optional Current Probe.



Function Keys and Result Screen

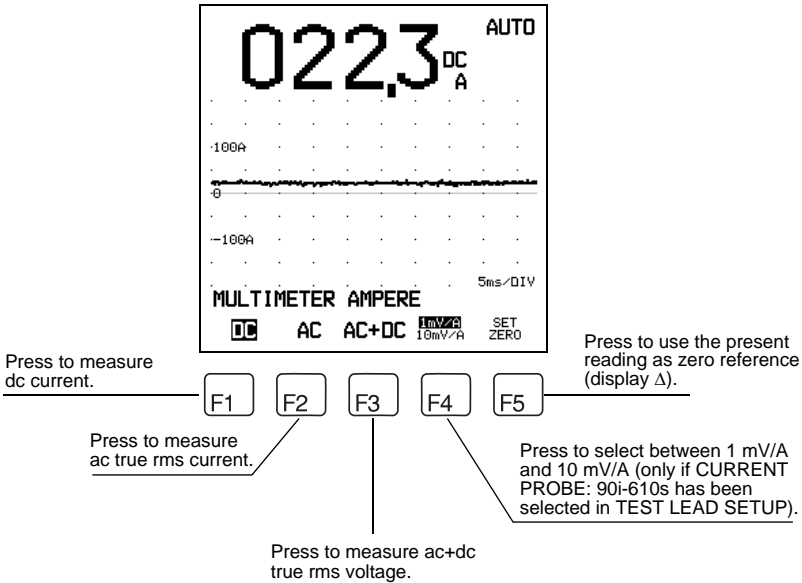
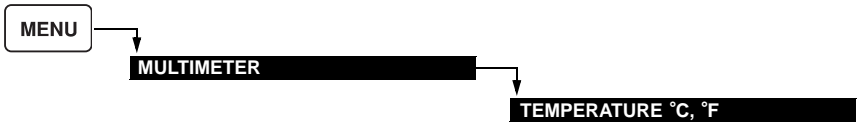

Figure 3-11. MULTIMETER AMPERE Display.

Don't forget to set the Current Probe to zero before using it for measurements (refer to the User Manual of the Current Probe).

Testing Temperature

Use this menu option to test temperature with the optional Temperature Probe or a probe that has a temperature sensitivity of 1 mV per degree Celsius or Fahrenheit.



Function Keys and Result Screen

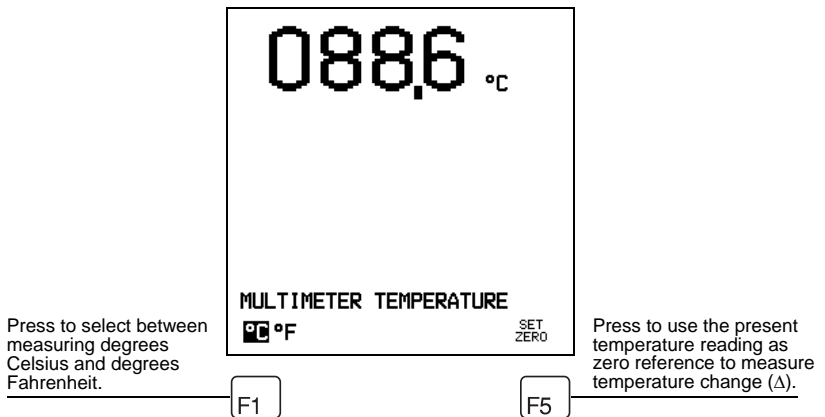

Figure 3-12. MULTIMETER TEMPERATURE Display.

In TEST LEAD SETUP, you can select TR90 Temperature Probe or a thermocouple probe with sensitivity 1 mV/°C or 1 mV/°F. Use the F1 key to set the corresponding temperature unit (°C or °F).

CHANGING THE VEHICLE DATA AND INSTRUMENT SETUP

There are two groups of setups in the main menu (see Figure 3-13):

VEHICLE DATA Use this menu option to enter the correct vehicle data, such as the number of cylinders on the vehicle under test.

INSTRUMENT SETUP Use this menu option to set the following:

- Optimal settings for display.
- Correct settings for hard copy to a printer.
- Language for menus and help text.
- Connection Help turned ON or OFF.
- Correct probe and test lead data.

Setup Overview

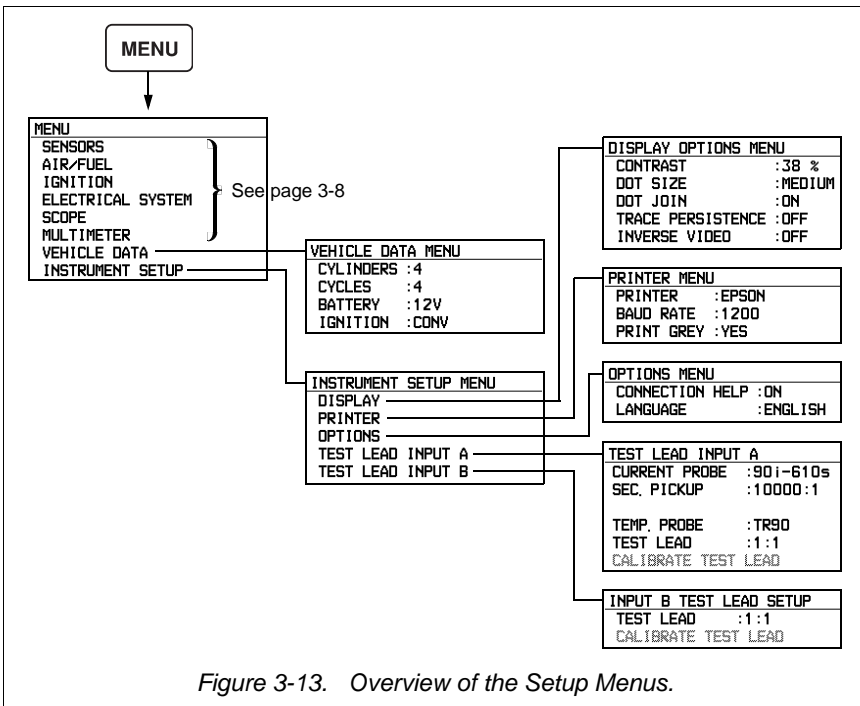

Figure 3-13. Overview of the Setup Menus.

Changing Vehicle Data

Use this menu option to set the vehicle data to match the vehicle under test. If they do not match, you could get incorrect test results and may not be able to select all available tests for this vehicle.

Because this menu is very important for the proper use of the test tool, it also appears at power-on as the start-up display.



CYLINDERS: 1, 2, 3, 4 (default), 5, 6, or 8. Specifies the number of cylinders on the vehicle under test.

CYCLES: 2 or 4 (default). Specifies a two- or four-stroke engine.

BATTERY: 6V, 12V (default), or 24V. Specifies battery voltage.

IGNITION: CONV (default), DIS, COP (Coil On Plug), or DIESEL. Specifies the type of ignition system. 'CONVentional' indicates systems using a distributor. DIS indicates Distributorless Ignition Systems. Coil on Plug systems have an ignition coil placed directly on top of each spark plug. Normally, secondary ignition tests are not possible on these systems, without a special adapter.

Changing Instrument Setup

These options give access to the following menus.

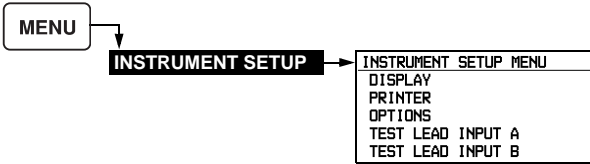

DISPLAY OPTIONS MENU

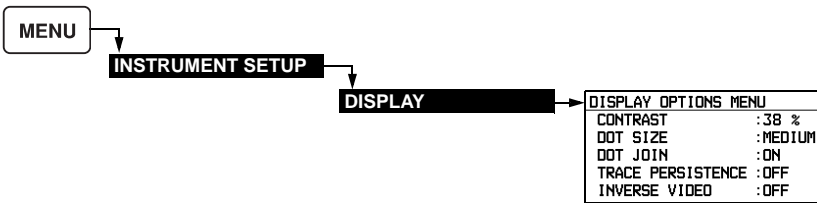

CONTRAST: This setting, expressed as a percentage, determines the contrast ratio between display text or graphics and the LCD background.
 0% is all white.
 100% is all black.
 In practice, the percentage will be somewhere between 35% and 80%, to have a good readable display.
 You can also change contrast by pressing the backlight key  and keeping it pressed until you reach the desired contrast level.

DOT SIZE: This setting determines the height of the dots used to display signal waveforms:
SMALL Dots displayed as small as possible (1-pixel height.) Waveforms appear thin.
MEDIUM Dots displayed 2-pixel height (default.) Waveforms appear medium thick.
LARGE Dots displayed 3-pixel height (maximum.) Waveforms appear thick.

DOT JOIN: Can be set On or Off (default is On). Think of a waveform as being a sequence of single dots (see Figure 3-14). When DOT JOIN is On, the dots are connected together as a solid line.

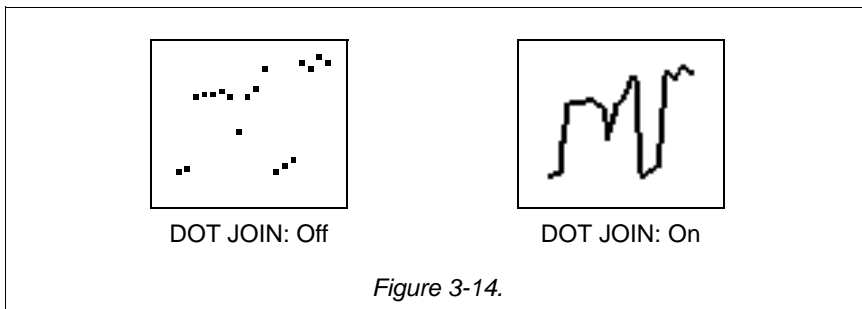
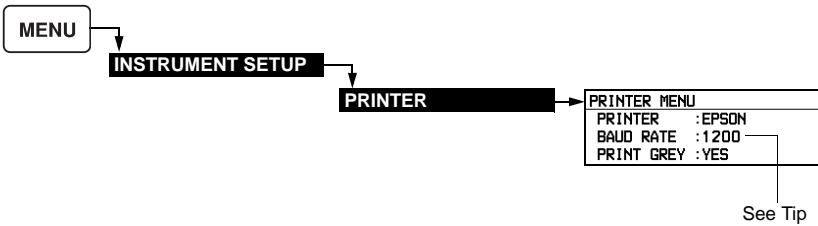

Figure 3-14.

TRACE PERSISTENCE: Can be set On or Off (default is Off). When set On, this keeps the signal waveform on the screen longer so it is easier to see any (fast) detail on the signal. It looks as if the waveform is refreshed at a slower rate.

INVERSE VIDEO: Can be set On or Off (default is Off.) Normally (when set Off) you see black text and graphics on a green background display. When you set INVERSE VIDEO On, you see green text and graphics on a black background display.

PRINTER MENU



- PRINTER:** Defines the type of printer connected to the test tool.
- BAUD RATE:** Defines the communication speed of the optical link between the test tool and the printer. This must correspond with the settings of the printer.
- PRINT GREY:** Can be set to Yes or No (Yes is default.) When set to Yes, grey parts as visible on screen are printed black. When set to No, grey parts are not printed.

Tip: Highlight this menu option and press  to get extended information about the settings needed for a connected printer.

OPTIONS MENU

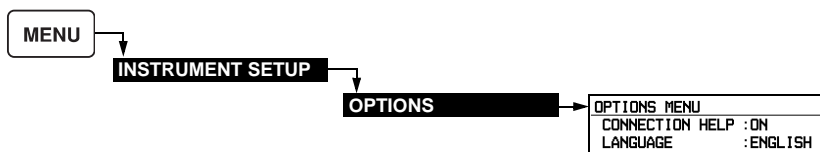

CONNECTION HELP: Can be set On (default) or Off. This setting is used to enable or disable display of connection help information during selection of a test.

LANGUAGE: This setting is used to select the local language or English for the information text display. This option is not available if only one language is implemented.

Changing Test Lead Setup

This menu option is used to configure the test tool for probes and test leads used for measurement. It is also used to calibrate a 10:1 test lead to match INPUT A or INPUT B.

When you use the standard test leads and probes supplied with the test tool, you do not need to make changes to the default setup.

Use this menu option to make the setup for non-standard test leads or probes.

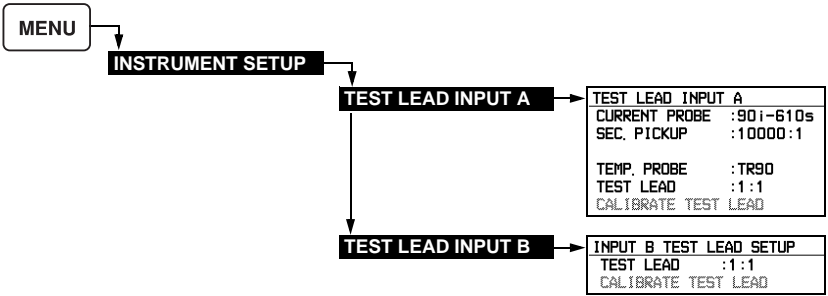

- CURRENT PROBE: Defines the type of current probe or its sensitivity in mV/A.
- SEC. PICKUP: Defines the type of secondary pickup or its attenuation factor.
- TEMP. PROBE: Defines the type of temperature probe or its sensitivity in mV/degree.
- TEST LEAD: Defines the type of test lead or its attenuation factor for the selected input (INPUT A or B).
- CALIBRATE TEST LEAD: This menu option starts calibration of a 10:1 test lead to match the input it is connected to (INPUT A or B). This menu option is disabled (displayed dimmed) if not a 10:1 test lead is selected. Regular calibration is necessary to meet specifications. For details, see Chapter 6 "Maintenance".

Chapter 4

Using the Additional Capabilities

USING THE RECORD FUNCTIONS	4-2
PLOT READINGS	4-3
Viewing the Stored Results from PLOT READINGS	4-5
MIN/MAX TRENDPLOT	4-6
Viewing the stored results from MIN/MAX TRENDPLOT	4-7
INTERMITTENT RECORD	4-8
Viewing the stored results from INTERMITTENT RECORD	4-9
FLIGHT RECORD	4-10
Viewing the stored results from FLIGHT RECORD	4-11
FREEZING, PRINTING, SAVING, AND RECALLING SCREENS .	4-12
USING CURSORS	4-14
USING THE SMOOTH FUNCTION	4-16

USING THE RECORD FUNCTIONS

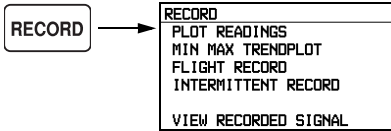



The group of functions in the RECORD MENU can help you to find faults that occur over time. PLOT READINGS and MIN MAX TRENDPLOT are very suitable to find faults in slowly changing processes, such as faults due to current change. INTERMITTENT RECORD is a fast recording function that continuously records without interruptions. FLIGHT RECORD records up to 40 successive screen snapshots in memory and is suitable to find irregularities in repetitive signal patterns. The recording functions store the results in memory. VIEW RECORDED SIGNAL allows you to examine the results later on.

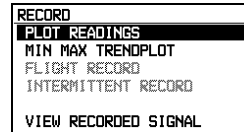

Do the following to start a recording function:

① Select and start the test you want to record.

②  Press to enter the RECORD menu.



③   Press to move the highlight to the desired recording function.

④   Press to select the highlighted recording function.

If the desired recording function is not possible for the selected test, the corresponding menu is shown dimmed (see the above figure.)



PLOT READINGS

This function allows you to see how different readings influence each other. Information is presented as a graphical plot of each reading. For example, you can display graphical plots of the PEAK-PEAK voltage and the DUTY CYCLE to see how these readings behave as FREQUENCY changes.

Do the following to start the PLOT READINGS recording function:

① Select and start the test you want to record.

②  Press to enter the RECORD menu.

③  Move the highlight to PLOT READINGS.

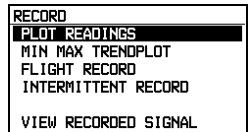

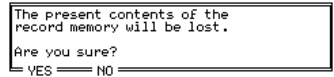

④  Press to select.

The Automotive ScopeMeter test tool displays a message when there is still an existing record in record memory that has to be overwritten before recording can start. This will not affect the 15 memory storage locations.



```

The present contents of the
record memory will be lost.
Are you sure?
= YES = NO =
  
```

Press  to preserve the record and cancel recording, or
 press  to overwrite the record and start recording.

When this function starts, a plot will start for each reading. See the following example for a single cylinder ignition test. The figure on the left shows the normal test display with the readings at the top. The figure on the right shows the display of each reading in the same order from top to bottom as displayed in the left figure.

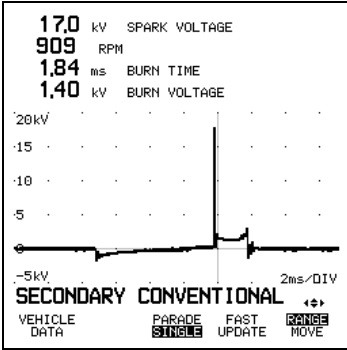

Normal test display
(example IGNITION SECONDARY SINGLE CYLINDER)

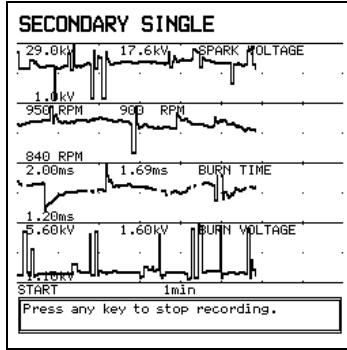

Display during
PLOT READINGS

Figure 4-1. Normal test display and PLOT READINGS display

The plots that appear on the display are also written to memory for later examination. Memory contents are preserved when the test tool is turned off. (See the next section 'Viewing the stored results from PLOT READINGS'.)

You can stop recording by pressing any key on the test tool (except ON/OFF).



When the graphical plots reach the right edge of the display, the horizontal time base is doubled so the plots continue from the centre of the display to the right. This process (time base rescaling) can repeat three times during about 16 minutes. After that, the plots will scroll from right to left across the screen.

Viewing the Stored Results from PLOT READINGS

There are two ways to view the recording results from PLOT READINGS:

1. While you are in PLOT READINGS recording, press any key. Continue the following procedure from step 4.
2. In all other cases, perform the following procedure.



①  Press to enter the RECORD menu.

②   Move the highlight to VIEW RECORDED SIGNAL

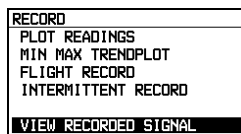
③  Press to select.



When you enter VIEW RECORDED SIGNAL, the display shows the readings that were on the display at the time you stopped recording. A vertical cursor appears at the location where these readings are valid, that is, at the end of the record. (See Figure 4-2)

④   Use the left/right arrow keys to move the cursor over the plots to read the sample values at the cursor location.

 Press this key to print the record to a connected printer. This is only possible via the optionally available RS232 cable.

 Press this key to exit from this display to return to the normal test display.

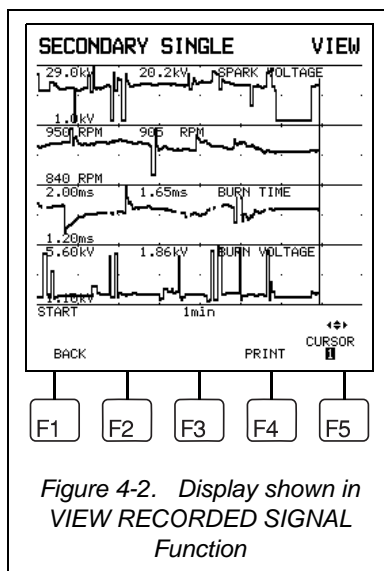







MIN/MAX TRENDPLOT

This function records the reading displayed at the top and keeps track of the maximum, minimum, and average value. The present reading remains displayed at the top, while the recorded values are listed below with their corresponding time stamps. As the average value is calculated over all readings from the beginning of recording up to and including the most recent reading, its time stamp indicates the complete recording time.

A graphical plot of the actual reading is displayed (see Figure 4-3).

Do the following to start the MIN MAX TRENDPLOT recording function:

- ① Select and start the test you want to record.
- ②  Press to enter the RECORD menu.
- ③   Move the highlight to MIN MAX TRENDPLOT.
- ④   Press to select MIN MAX TRENDPLOT. If there is still existing record data in memory, press  to preserve this data, or press  to overwrite this data, and start recording.

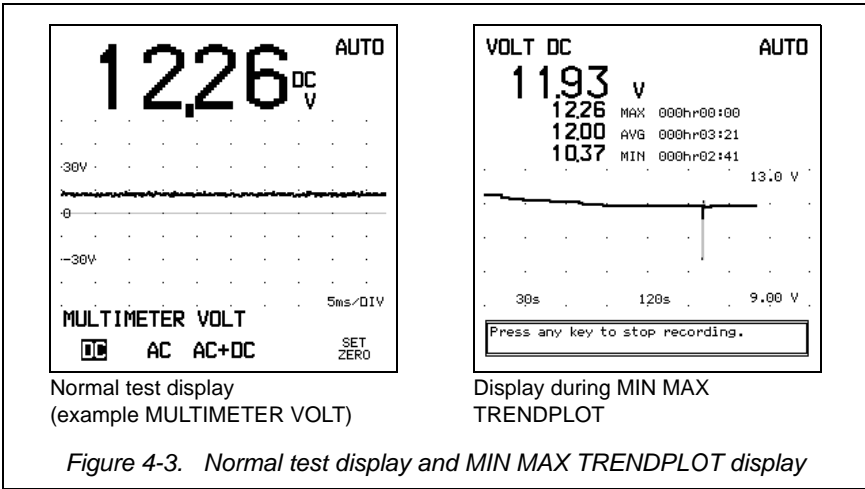
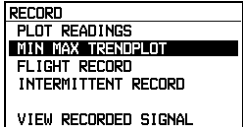

The graphical plot is displayed in the same way as PLOT READINGS, except in this function, time base rescaling does not stop after 16 minutes. Recording stops when you press any key on the Automotive ScopeMeter test tool.

Viewing the stored results from MIN/MAX TRENDPLOT

Use the same procedure as used for 'Viewing the stored results from PLOT READINGS' to enter the VIEW RECORDED SIGNAL function.







When you enter this function, the display shows the same information that was shown when you stopped recording. Unlike PLOT READINGS, in this function there is no cursor available to scan the displayed plot.

INTERMITTENT RECORD

This recording function can help you find faults that occur during short periods of time. Such a fault, also called an intermittent, can for example be a signal that disappears occasionally due to a poor connection or broken wire.

The test tool display has about 9.5 horizontal divisions to show a waveform. The length in time of the waveform which depends on the time base setting, may be too short to capture a faulty signal. However, the INTERMITTENT RECORD function can store the signal waveform for a period that corresponds to 1280 divisions in a cyclic memory (endless loop). The length in time equals 1280 times the time base setting. For example, if the time base is set to 100 ms per division, the recorded waveform is 128 seconds long. From that time on the first waveform sample will shift out of memory to make space for a new sample, and so forth until you stop recording by pressing any key.

Do the following to start INTERMITTENT RECORD:

- ① Select and start the test you want to record.
- ②  Press to enter the RECORD menu.
- ③   Move the highlight to INTERMITTENT RECORD.
- ④   Press to select INTERMITTENT RECORD. If there is still existing record data in memory, press  to preserve this data, or press  to overwrite this data and start recording.

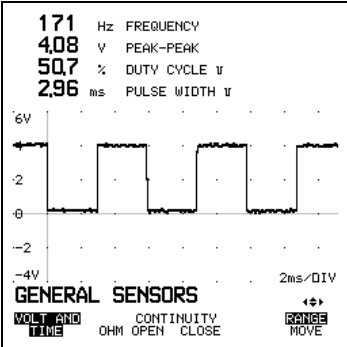
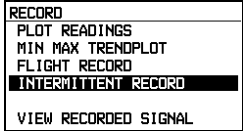

Normal test display (example GENERAL SENSORS)

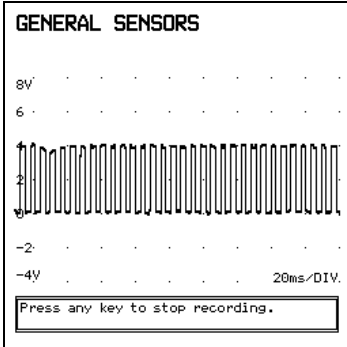

Display during INTERMITTENT RECORD ¹⁾

Figure 4-4. Normal test display and INTERMITTENT RECORD display

1) For slow timebase settings, the display will be blank for a certain time.

The time base setting during INTERMITTENT RECORD is 20 ms per division or slower (time base >20 ms/division). If the current time base is faster than 20 ms per division, INTERMITTENT RECORD records at 20 ms per division.



Viewing the stored results from INTERMITTENT RECORD



Do the following to view the results from INTERMITTENT RECORD:

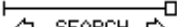

If you are in the INTERMITTENT RECORD mode, press any key to stop recording and continue the following procedure from step 4.

In all other cases, perform the next procedure.

- ① through ③ Use the same procedure as used for 'Viewing the stored results from PLOT READINGS' to enter the INTERMITTENT RECORD function (steps 1 through 3.)

- ④  Use these keys to browse through the recorded screens to search for the desired signal event.
-  

- CURSOR
⑤  Press to select the cursor you want to move.
- 

- ⑥   Use the left/right arrow keys to move the selected cursor to the location where you want to read the sample values.

- PRINT
 Press this key to copy the screen to the connected printer. This is only possible via the optionally available RS232 cable.

- BACK
 Press this key to exit from this display and return to the normal test display.

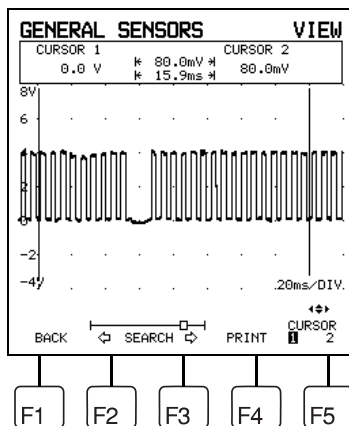



FLIGHT RECORD

This function stores up to 40 successive **screen snapshots** in memory. You can view the last 40 (or less if memory is not full) screens stored in the record memory. This function is suitable for repetitive signals such as ignition patterns, not for intermittents. The time base setting possible during FLIGHT RECORD is 200 ms per division or faster (time base <200 ms/division). If the current time base is slower than 200 ms per division, FLIGHT RECORD records at 200 ms per division.





Perform the following to start the FLIGHT RECORD function:

① Select the function and start the the test you want to record:

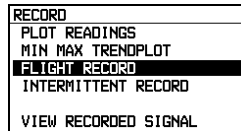
②  Press to enter the RECORD menu.

③   Move the highlight to FLIGHT RECORD.



④   Press to select FLIGHT RECORD. If there is existing data in memory, press  to preserve this data and cancel recording, or press  to overwrite this data, and start recording.

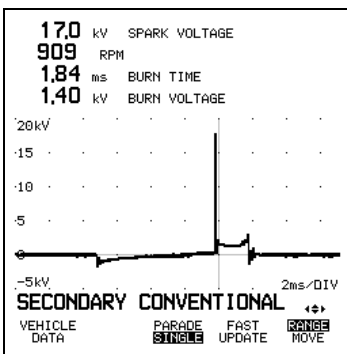

Ignition Single Cylinder Display

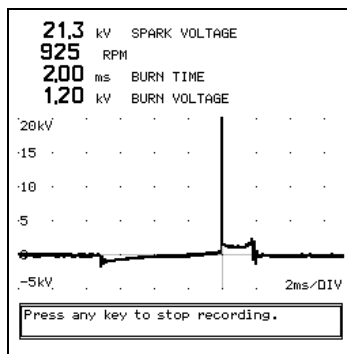

Display during FLIGHT RECORD

Figure 4-5. Normal Test Display and FLIGHT RECORD Display

Viewing the stored results from FLIGHT RECORD.



Do the following to view the results from FLIGHT RECORD:

If the FLIGHT RECORD function is busy recording, press any key to stop recording and perform step 4 in the next procedure (skip steps 1 through 3).

In all other cases, perform next steps.

① through ③ Use the same procedure as used for 'Viewing the stored results from PLOT READINGS' on page 4-5, to enter the VIEW RECORDED SIGNAL function (steps 1 through 3.)

④  Use these keys to browse through the recorded screens.

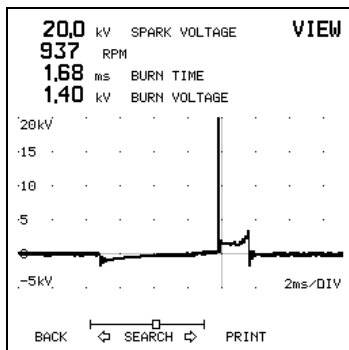

FREEZING, PRINTING, SAVING, AND RECALLING SCREENS

FREEZE



Freezes the display and shows the Function Key Menu to save, recall, print the actual screen, or to clear the memory. HOLD appears in the top right of the display if the test tool was busy measuring.

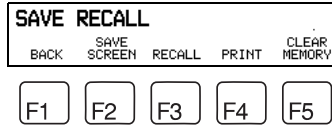

BACK



Press this key to resume measuring or to return to the previous display.

PRINT



Copies the screen to the printer. (Make sure that the test tool setup matches with the connected printer. See the section "CHANGING INSTRUMENT SETUP" in Chapter 3.)

SAVE SCREEN



Saves the present screen in the next free memory location.

A message is displayed to tell you in which memory location the screen is saved.

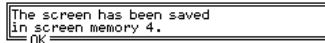

When all memory locations are filled from previous save actions, a message is displayed asking to overwrite a memory location (press F1) or to cancel saving (press F2).

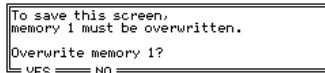

You can recall a saved screen from memory to compare it with actual test results.

RECALL

F3

Displays the screen last saved in memory.

The screen from memory 5 is displayed.
OK

F1

OK

F1

Press this key to remove the message.

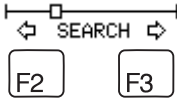

Use these keys to move the screen memory pointer —□— to the left (F2) or the right (F3) to display the previous or the next

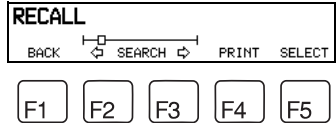

screen in memory. The pointer can move only if more than one screen has been saved in memory. Look up the desired screen.

PRINT

F4

Press this key if you want to copy the screen to the printer. The printer must be connected via the optionally available RS232 cable.

SELECT

F5

Press to select the displayed screen. The test tool activates the settings that are valid for the recalled screen. The waveform(s) from the recalled screen are displayed in grey to enable distinction from the active waveform(s) for comparison.

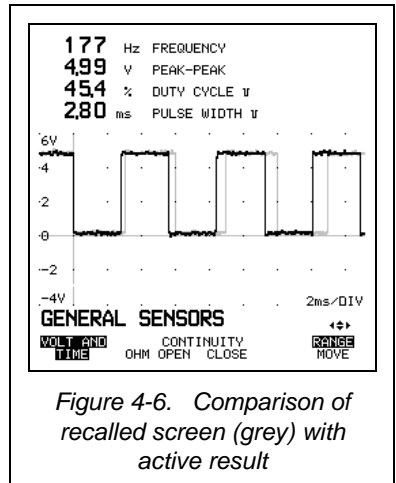

Figure 4-6. Comparison of recalled screen (grey) with active result

USING CURSORS

A cursor is a vertical line placed over the displayed waveform to measure values at certain points. This function is not possible for all tests. Use cursors as follows:



Press to display the Function Key Menu for cursor operation. If cursor operation is not possible for the actual measurement, the test tool beeps to alert you.

Two cursors (vertical lines) appear on the display. The left cursor is named CURSOR 1, the right CURSOR 2.

CURSORS
ON OFF

Press to set CURSORS ON or OFF.



CURSOR

1 2

Select the cursor you want to move (1 or 2).



Left/right arrow keys move the cursor.

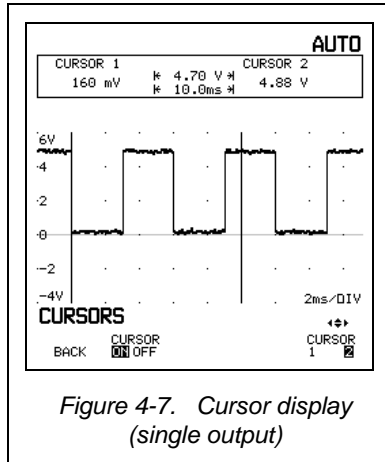

Figure 4-7. Cursor display (single output)

The top display shows a rectangular box containing readings related to values at the cursor positions. (See Figures 4-7 and 4-8)

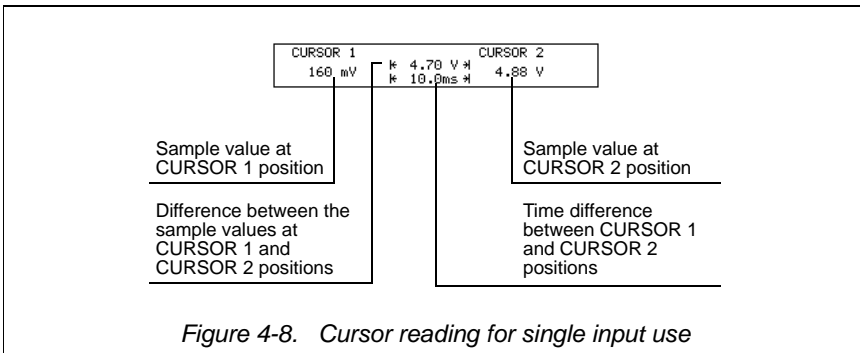

Figure 4-8. Cursor reading for single input use

When you use cursors in DUAL INPUT SCOPE, the display also gives cursor readings for INPUT B. There is no difference in sample values given at the cursors as seen in single input mode. (See Figure 4-9 and 4-10)

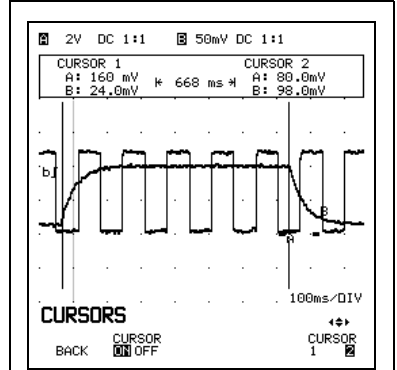

Figure 4-9. Cursor display (dual output)

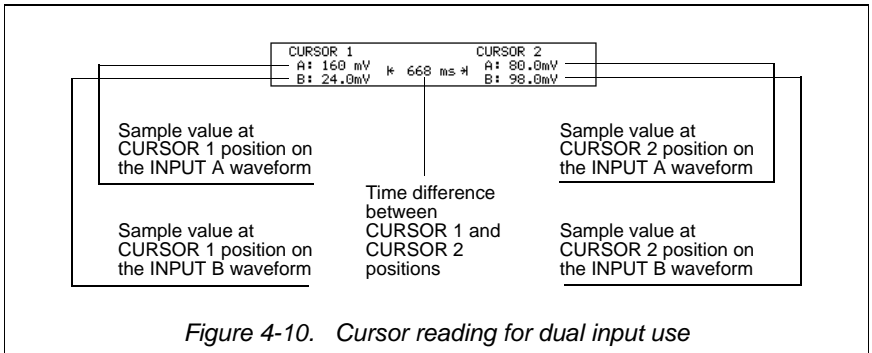

Figure 4-10. Cursor reading for dual input use

USING THE SMOOTH FUNCTION

This function allows you to adjust a filter that removes noise from displayed waveforms.

Use this function if the displayed waveform exhibits too much noise or if readings are unstable so you can hardly examine the results.

CAUTION: The smooth function also removes spikes from the waveform. If the signal normally exhibits spikes, they are removed (See Figure 4-11). SMOOTH is disabled for IGNITION functions

Note: Always try to prevent noise as much as possible by correct grounding and by using shielded test leads.



Displays the Function Key Menu for SMOOTH control. Each automotive test has its own default (NORMAL) smooth setting.



Press the F2 key to minimize smoothing. When you set smooth to the minimum, the test tool turns glitch detection on to display glitches (not valid for MULTIMETER functions).



Press the F3 key to increase smoothing. (See the following figure.)

NORMAL



Press this key to return to the normal (default) smooth setting for the active test.

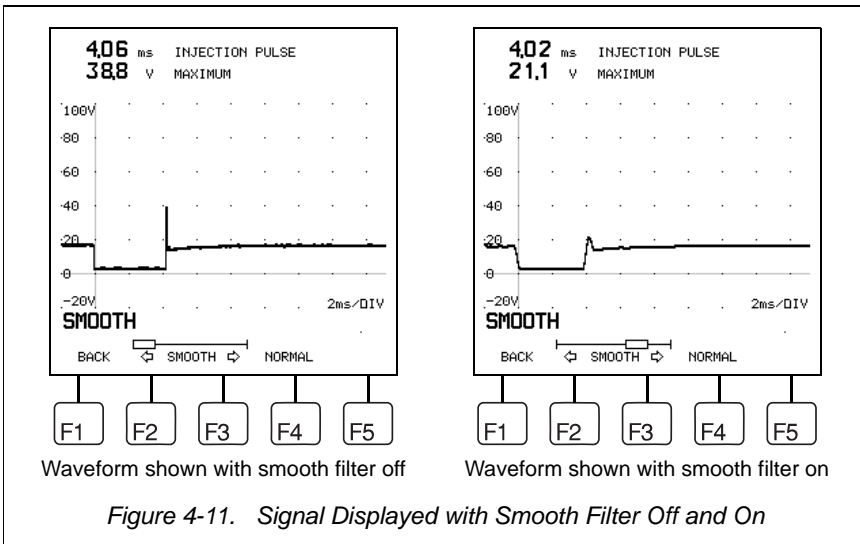

Figure 4-11. Signal Displayed with Smooth Filter Off and On

Chapter 5

Automotive Applications

SENSORS	5-3
3. Manifold Absolute Pressure (MAP)	5-3
2a. Oxygen Sensor (Lambda) (O2) — Zirconia and Titania	5-6
2b. Dual Oxygen Sensor (Dual Lambda or Dual O2)	5-11
3. Temperature	5-13
4. Throttle Position Sensor (TPS) — Potentiometer and Switched	5-16
5. Crankshaft/Camshaft Position (CPS)	5-21
6. Ride Height (Position) — Potentiometer	5-26
7. Vehicle Speed Sensor (VSS) — Magnetic, Hall-Effect, and Optical ..	5-29
8. Anti-Lock Wheel Speed Sensor (ABS) — Magnetic	5-33
AIR/FUEL	5-37
9. Air Flow Sensors	5-37
10. Exhaust Gas Recirculation (EGR)	5-43
11. Fuel Injection (FI)	5-46
12. Mixture Control Solenoid (MC) (Pulse Width	5-52
13. Idle Air Control / Idle Speed Control (IAC/ISC)	5-54
IGNITION	5-57
14. Knock Sensor — Piezo Crystal (Burst Pattern)	5-57
15. Secondary Ignition	5-60
16. Primary Ignition	5-67
17. Distributor Triggering	5-69
18. Relative Compression	5-73
19. Timing Advance	5-76
ELECTRICAL SYSTEM	5-79
20. Battery Test	5-79
21. Charging	5-81
22. Solenoid and Clamping Diode Test	5-85
23. Voltage Drop	5-88
24. Voltage Tests	5-90
DIESEL	5-92
25. Diesel RPM Measurements and Diesel Injection Pattern Display	5-94
26. Diesel Advance Measurement	5-96

AUTOMOTIVE APPLICATIONS

Applications are divided into four groups:

1. SENSORS Measurements on sensor-type devices.
2. AIR/FUEL Measurements on devices used in the vehicle's air and fuel management system.
3. IGNITION Measurements on devices used in conjunction with the vehicle's ignition system.
4. ELECTRICAL SYSTEM Measurements on devices used in the vehicle's electrical system.

NOTES:

This chapter provides many typical automotive tests. These tests are designed to help you learn how to use the Automotive ScopeMeter test tool. These tests DO NOT REPLACE test procedures that apply to particular vehicles. Therefore consult your vehicle manufacturer's service manual to use correct test procedures.

The application examples given in this chapter represent often used applications with typical specifications. Some vehicle manufacturers use other systems with different specifications and require test methods different from those mentioned in this application chapter.

SENSORS

1 Manifold Absolute Pressure (MAP)

The manifold absolute pressure sensor provides an electrical signal to the ECU that represents engine load. This data, in the form of a frequency modulated square wave or voltage level (depending on the manufacturer), is used by the computer to alter the fuel mixture and other outputs.





High pressure occurs when the engine is under a heavy load, and low pressure (high intake vacuum) occurs when there is very little load. A bad MAP sensor can affect the air-fuel ratio when the engine accelerates and decelerates. It serves the same basic function as a power valve in a carburetor. It may also have some effect on ignition timing and other computer outputs.

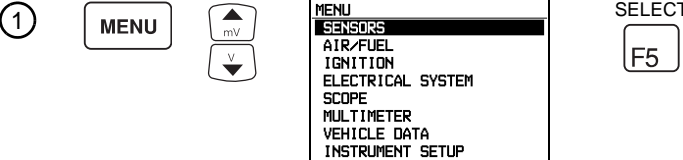

Measurement Conditions for the MAP Sensor Test

- Key ON, Engine OFF, with vacuum applied to the sensor's vacuum input using a hand pump to simulate the vacuum.
- or
- Engine RUNNING, monitor the signal at idle while increasing rpm.

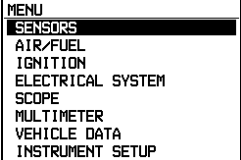
Test Tool Key Sequence for the Digital MAP Sensor Test

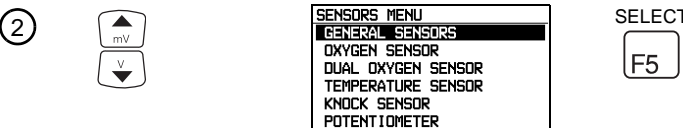
- 

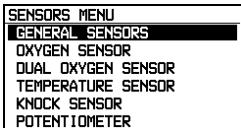
①    
- 

②   
- ③ Connect the test leads as displayed by the test tool's Connection Help banner and as shown in Figure 5-1.
- 

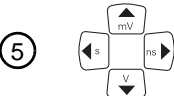
④  Starts the Digital MAP sensor test.
- 

⑤  If necessary, use the arrow keys for ranging. You can use INTERMITTENT RECORD to log the test results.

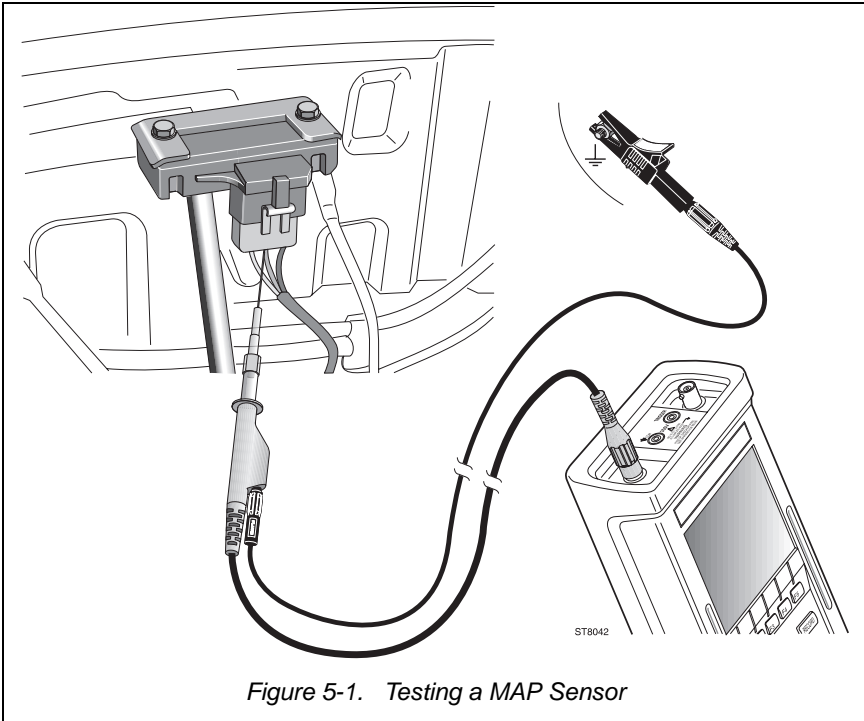

Figure 5-1. Testing a MAP Sensor

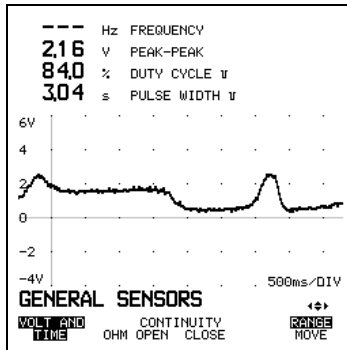
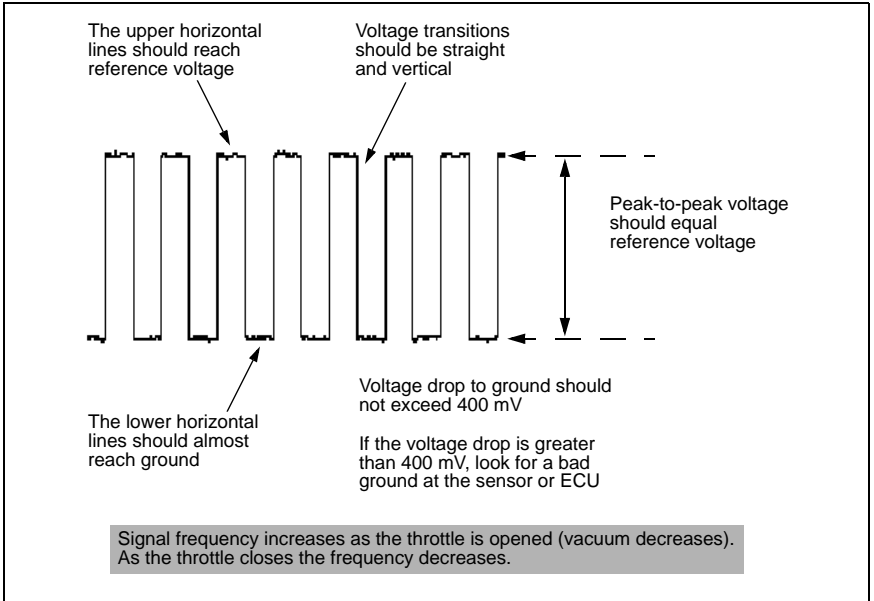

Figure 5-2. Result Display from a Map Sensor Test

The INTERMITTENT RECORD function is a powerful means to watch the signal over time. This function gives you time to activate the sensor while recording is in progress, and then stop recording to display the result. See the example for Oxygen Sensor on page 5-10.

Manifold Absolute Pressure Sensor (Map) Digital



Manifold Absolute Pressure Sensor (Map) Analog

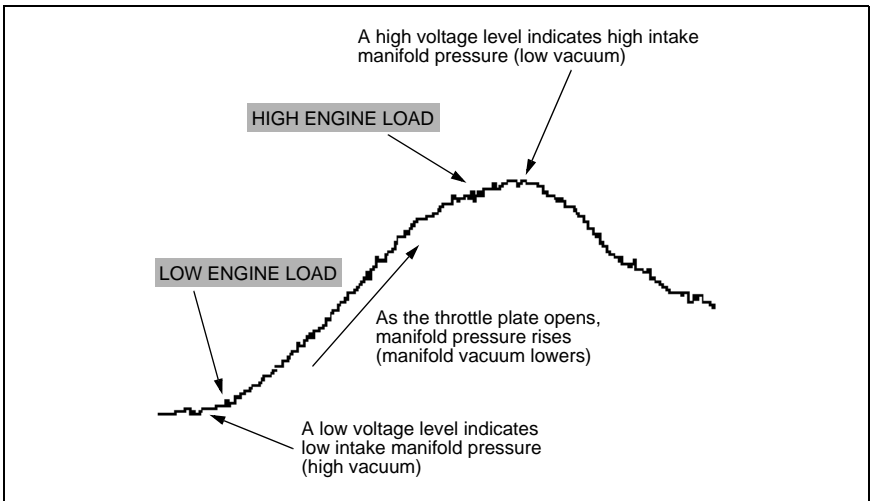

Specifications may vary. Consult manufacturer's specifications.

2a Oxygen Sensor (Lambda) (O₂) — Zirconia and Titania

An oxygen sensor provides an output voltage that represents the amount of oxygen in the exhaust stream. The output voltage is used by the control system to adjust the amount of fuel delivered to the engine.



The zirconia-type oxygen sensor acts as a battery, providing high output voltage (resulting from a rich condition) and low output voltage (indicating a lean condition.)

The titania sensor, used on some vehicles, changes resistance as the oxygen content of the exhaust gas changes. This results in a low output voltage (from a rich condition) and a high output voltage (from a lean condition).

Measurement Conditions for the Oxygen Sensor Test



- Run the engine until the oxygen sensor is warmed to at least 600°F (315°C), in closed loop. Use jumper leads or back probe to make connection at the sensor wiring connector.
- Run the engine at idle while increasing engine speed.

Test Tool Key Sequence

①   

MENU
SENSORS
AIR/FUEL
IGNITION
ELECTRICAL SYSTEM
SCOPE
MULTIMETER
VEHICLE DATA
INSTRUMENT SETUP



 SELECT

②  

SENSORS MENU
GENERAL SENSORS
OXYGEN SENSOR
DUAL OXYGEN SENSOR
TEMPERATURE SENSOR
KNOCK SENSOR
POTENTIOMETER

 SELECT

③ Connect the test leads as displayed by the test tool's Connection Help and shown in Figure 5-3.

④   Starts the oxygen sensor test.

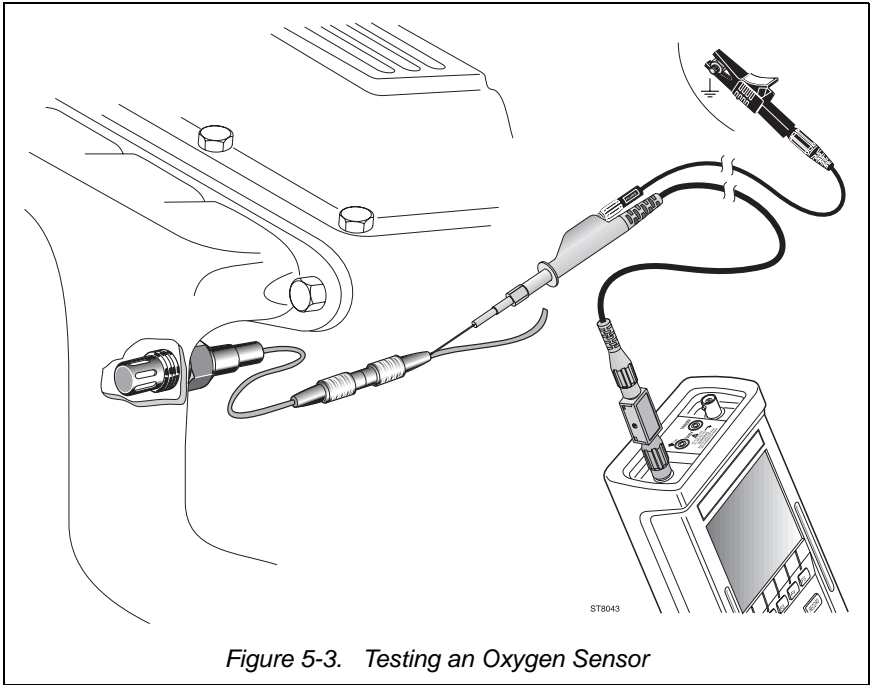

Figure 5-3. Testing an Oxygen Sensor

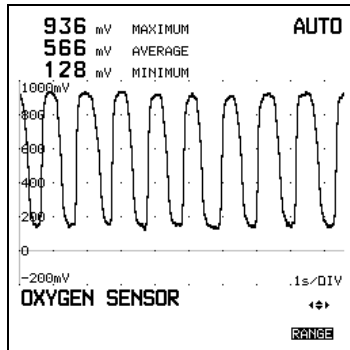
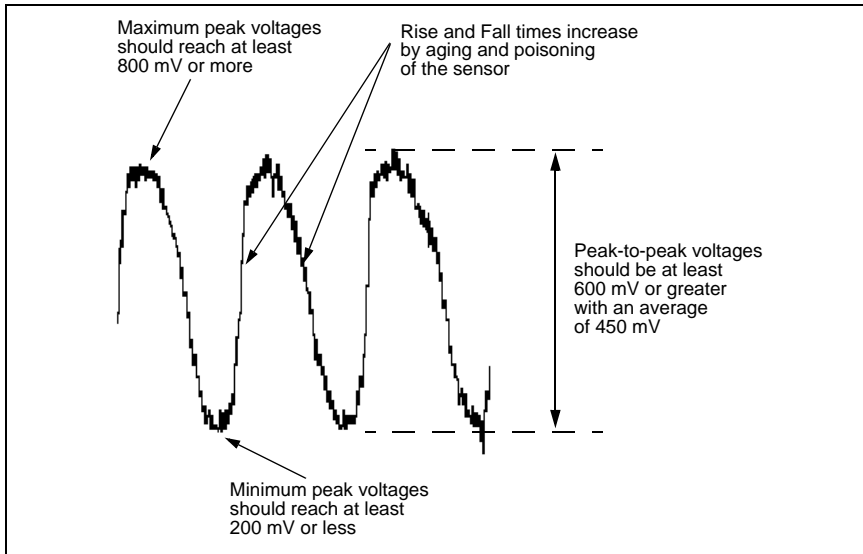

Figure 5-4. Result Display from an Oxygen Sensor Test.

Oxygen Sensor - Zirconia



Specifications may vary. Consult manufacturer's specifications.

Oxygen Sensor test with RECORD - PLOT READINGS

The PLOT READINGS function allows you to record the minimum, maximum, and average voltage readings over time. This is useful for tracking a coated sensor or one that has an intermittent ground on the exhaust manifold.

Test Tool Key Sequence for an Oxygen Sensor Test with Flight Record

① Start the OXYGEN SENSOR test as described above.

② **RECORD** Press to display the RECORD menu.

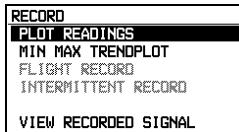

If there is still record data in memory that may be cleared, perform step 3 to start recording.

③ **YES**
F1 Press to start recording.

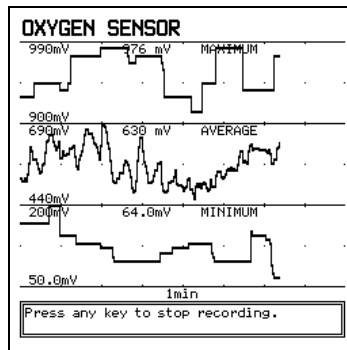

④ Press any key to stop recording.



⑤ Use the arrow keys to move the cursor to the desired position to read the MAXIMUM, AVERAGE, and MINIMUM values at that position.

You can turn the test tool off and read this record later via the RECORD - DISPLAY RECORDED SIGNAL function. (See Chapter 4 for more information.)

Oxygen Sensor test with RECORD → INTERMITTENT RECORD

The Intermittent Record function is an endless loop recorder that allows you to continuously record the oxygen sensor screens for over 21 minutes. The oxygen sensor is useful for emission system analysis, which allows easy fuel and ignition system diagnosis.

① Start the OXYGEN SENSOR test as described above.

② **RECORD** Press to display the RECORD menu.

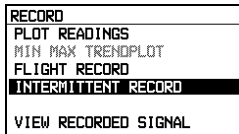

If there is still record data in memory that may be cleared, perform step 3 to start recording.

③ YES **F1** Press to start recording.

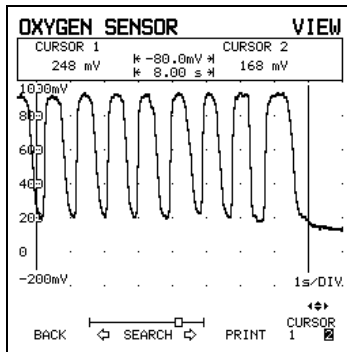

④ **F2** Press to scroll backward through the record.

F3 Press to scroll forward through the record.

You can turn the test tool off and read this record later via RECORD → VIEW RECORDED SIGNAL function. (See Chapter 4 for more information.)





2b Dual Oxygen Sensor (Dual Lambda or Dual O₂)



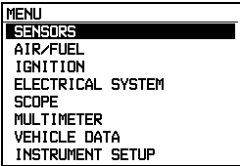

Both oxygen sensors provide an output voltage that represent the amount of oxygen in the exhaust stream respectively before and after the catalytic converter. The leading sensor signal is used as feedback for mixture control. The signal from the trailing sensor is used by the vehicle computer to test efficiency of the catalytic converter. The signal amplitude from the trailing sensor will increase when the efficiency of the catalytic converter declines over years. The difference in voltage amplitude from the sensors is a measure for the ability of the catalytic converter to store oxygen for the conversion of harmful exhaust gases.

Measurement Conditions for the Oxygen Sensor Test

- Run the engine until the oxygen sensor is warmed to at least 600°F (315°C), in closed loop. Use jumper leads or back probe to make connection at the sensor wiring connector.
- Run the engine at idle while increasing engine speed.

Test Tool Key Sequence for the Temperature Sensor Test

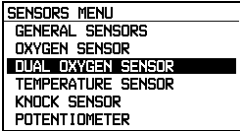
①     

②    

③ Connect the test leads as displayed by the test tool's Connection Help and shown in Figure 5-5.

④  Start the temperature sensor test now.

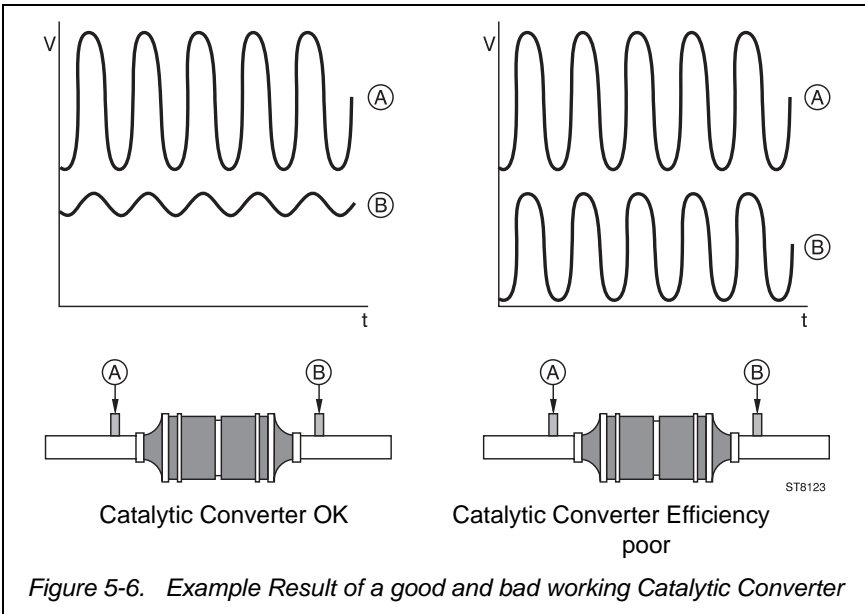
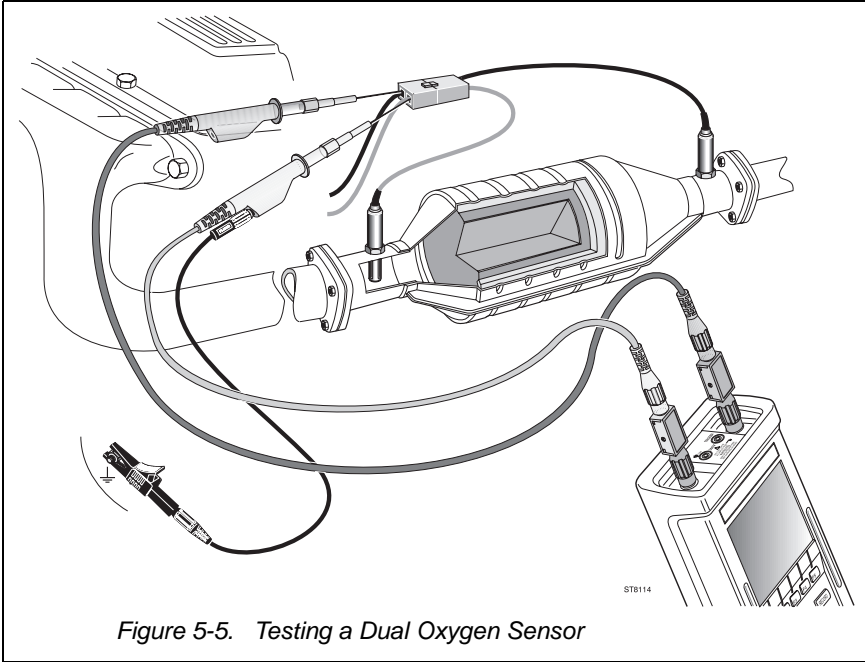

3 Temperature





(CTS) Coolant Temperature Sensor and (IAT) Intake Air Temperature Sensor

Most temperature sensors are **Negative Temperature Coefficient (NTC)** thermistors, a resistor made from a semiconductor material. The electrical resistance changes greatly and predictably as temperature changes. The resistance of the NTC thermistor goes down as its temperature goes up, and its resistance goes up when the temperature goes down.

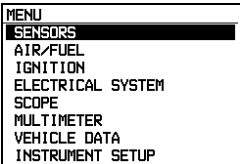

Measurement Conditions for the Temperature Sensor Test

- Turn the key ON, Engine OFF. With the sensor wiring harness connected, measure the output voltage (engine COLD).or
- Run the engine and monitor the voltage decrease (NTC) as the engine warms.
- This same test sequence can be performed while monitoring the resistance value of the sensor. The sensor must then be disconnected.

Test Tool Key Sequence for the Temperature Sensor Test

①    

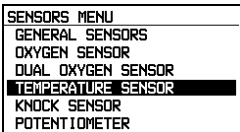
The menu screen displays the following options: MENU, SENSORS (highlighted), AIR/FUEL, IGNITION, ELECTRICAL SYSTEM, SCOPE, MULTIMETER, VEHICLE DATA, INSTRUMENT SETUP.

②   

The menu screen displays the following options: SENSORS MENU, GENERAL SENSORS, OXYGEN SENSOR, DUAL OXYGEN SENSOR (highlighted), TEMPERATURE SENSOR, KNOCK SENSOR, POTENTIOMETER.

- ③ Connect the test leads as displayed by the test tool's Connection Help and shown in Figure 5-7.

④  Start the temperature sensor test now.

or



You should disconnect the sensor before you press F2 to test the sensor resistance.

Use the optional TR90 temperature probe to measure the actual coolant or intake air temperature. (See Chapter 3 "Using Multimeter Functions", section "Testing Temperature".)

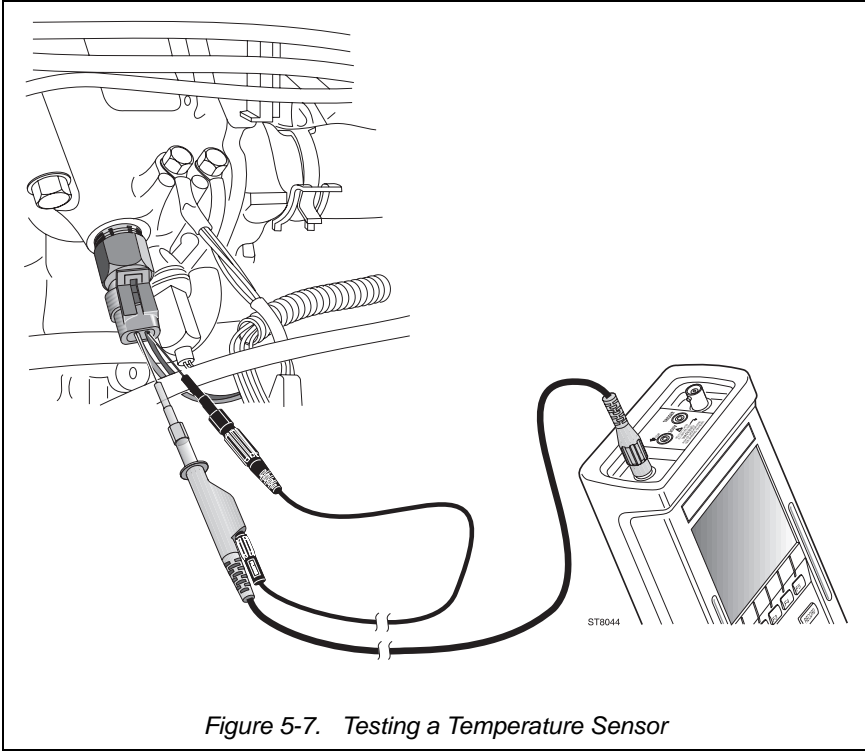

Figure 5-7. Testing a Temperature Sensor

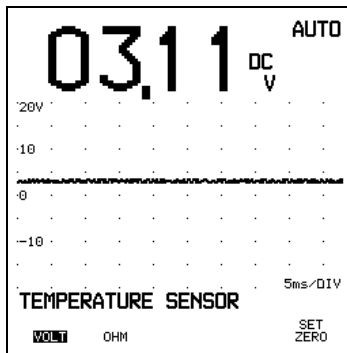
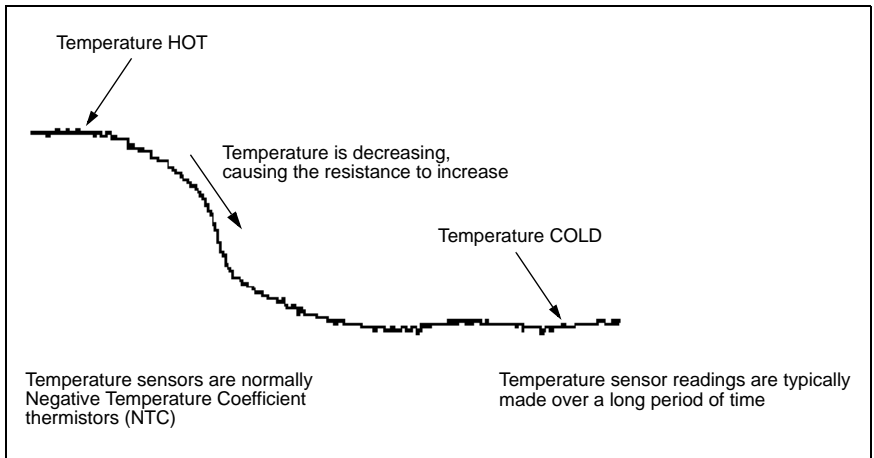

Figure 5-8. Result Display from a Temperature Sensor Test

Coolant and Intake Air Temperature Sensors - NTC Thermistors



Specifications may vary. Consult manufacturer's specifications.

4 Throttle Position Sensor (TPS) — Potentiometer and Switched

Throttle position sensors (TPS) are a common source of faults in today's on-board computers. Some people think of a TPS as a replacement for an accelerator pump on throttle body or port fuel-injected engines, but it is much more. A TPS tells the on-board computer how far the throttle is open, whether it is opening or closing and how fast. As the resistance of the TPS changes, so does the voltage signal returning to the computer.

Potentiometer Sensor

Variable position sensors provide a dc voltage level that changes as the arm on a variable resistor (potentiometer) is moved. A TPS is simply a variable resistor connected to the throttle shaft. The changing dc voltage is used as an input to the electronic control module.

Switched Type of Sensor

Some manufacturers use switches to determine the position of the throttle. The signal to the ECU from this switch tells the ECU to control the idle speed (switch closed, throttle closed) or not to control the idle speed (switch open because the driver has moved the throttle linkage from the closed position). Another switch closes to tell the ECU that the throttle is wide open.

The linear throttle position sensor is mounted to the throttle shaft and has two movable contacts traveling along the same axis as the throttle valve. One is used for the throttle opening angle and the other for the closed throttle signal. Insure that the correct wires are monitored to determine a malfunctioning sensor.









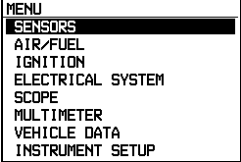

Testing the DC Voltage from the Throttle Position Sensor

This is an in-circuit test (nothing disconnected) on the Throttle Position Sensor to measure the dc voltage delivered.

Measurement Conditions for the Throttle Position Sensor Voltage Test

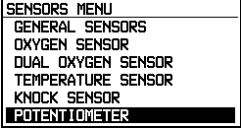
- Turn the key ON, engine OFF. Sweep the throttle to the wide open position and then to the closed position again, or vice versa.

Test Tool Key Sequence

- ①     
- ②    
- ③ Connect the test leads as displayed by the test tool's Connection Help and shown in Figure 5-9.
- ④   Starts the potentiometer sweep test.

To obtain the waveform shown in Figure 5-10 (Potentiometer-type sensor) or the waveform shown in Figure 5-11 (Switched-type sensor), sweep the sensor arm from closed to full open, and back to closed.

To obtain a continuous pattern while on a road test, simply increase the time base to 500 ms or greater.

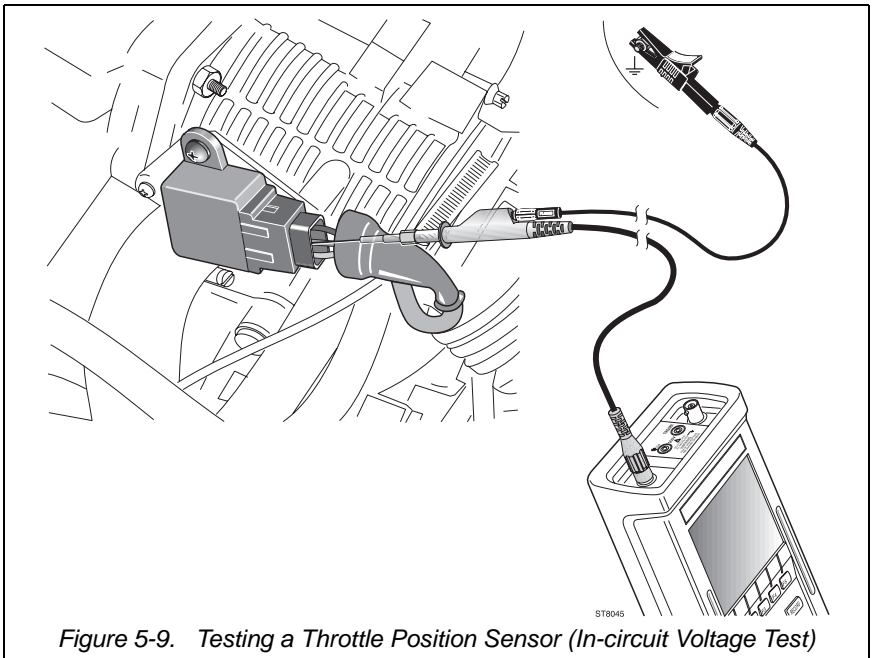

Figure 5-9. Testing a Throttle Position Sensor (In-circuit Voltage Test)

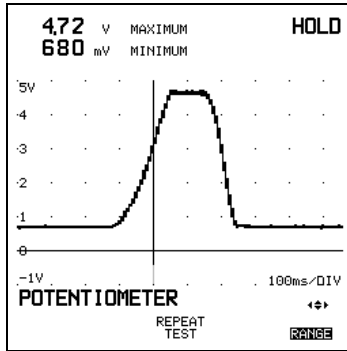

Figure 5-10. Result Display of a Voltage Test on a Potentiometer-Type Throttle Position Sensor

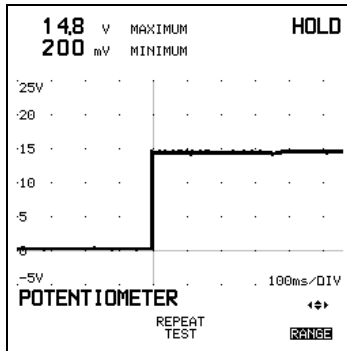
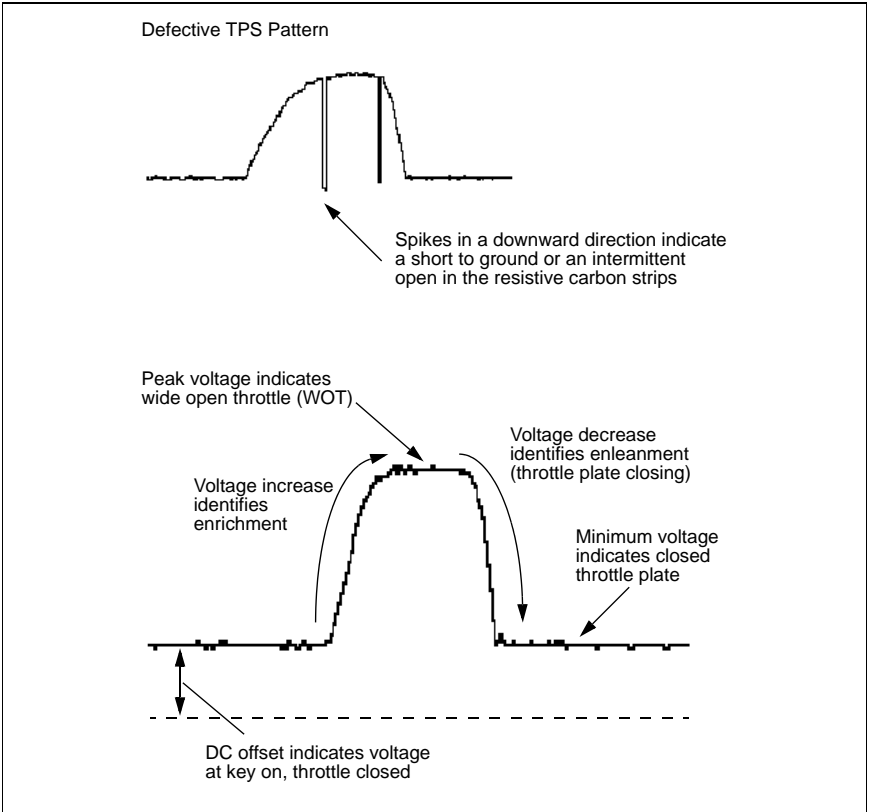

Figure 5-11. Result Display of a Voltage Test on a Switched-Type Throttle Position Sensor

Throttle Position Sensor (Potentiometer)



Specifications may vary. Consult manufacturer's specifications.

Throttle Position Sensor - Switch Type

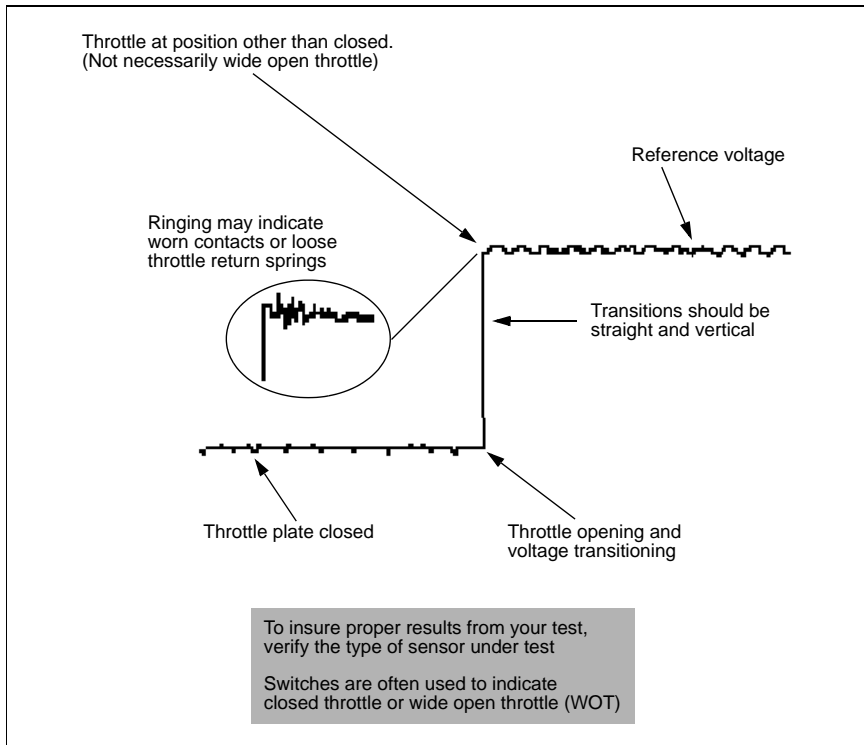

Specifications may vary. Consult manufacturer's specifications.

5 Crankshaft/Camshaft Position (CPS)

Hall-Effect, Magnetic, and Optical Sensors

Magnetic Sensors (Variable Reluctance Sensors) do not require a separate power connection. They have two shielded connecting wires for the stationary magnet's coil. Small signal voltages are induced as the teeth of a trigger wheel pass through the magnetic field of this stationary magnet and coil. The trigger wheel is made of a low magnetic reluctance steel.

Crankshaft Position Sensor (CPS), Anti-Lock Brake Sensor (ABS), and Vehicle Speed Sensor (VSS) are examples of Variable Reluctance Sensors. Output voltage and frequency vary as vehicle speed changes.

In a **Hall-Effect Sensor**, a current is passed through a semiconductor that is positioned close to a varying magnetic field. These variations can be caused by the turning of a crankshaft or the rotation of a distributor shaft.

Hall-Effect Sensors are used in Crankshaft Position Sensors and Distributors. Output voltage amplitude is constant; frequency changes as rpm changes.

Optical Sensors use a rotor disk that separates LEDs from optical pickups. Small openings, or slits, in the rotor disk, allow light from the LEDs to energize the optical pickups. Each time a slit aligns with the LEDs and optical pickups, the pickup sends out a pulse.



The resulting voltage variations can then be used as a reference signal for other systems. The output voltage amplitude is constant; frequency changes as rpm changes.

A cam sensor is commonly installed in place of the ignition distributor. The sensor sends electrical pulses to the coil module and gives data on camshaft and valve position.

Measurement Conditions



- Look for presence of a signal. If there is a signal, the problem is somewhere else. If there is no signal, look for a defective sensor or a wiring problem.
- If you are diagnosing a NO START CONDITION, connect the test tool as described in the test tool's Connection Help and crank the engine.
- If the engine runs, connect the test tool as described in the test tool's Connection Help and start the engine. Run the test at idle and at higher rpm values.

Test Tool Key Sequence

①   

MENU
SENSORS
AIR/FUEL
IGNITION
ELECTRICAL SYSTEM
SCOPE
MULTIMETER
VEHICLE DATA
INSTRUMENT SETUP

 SELECT 

②  

SENSORS MENU
GENERAL SENSORS
OXYGEN SENSOR
DUAL OXYGEN SENSOR
TEMPERATURE SENSOR
KNOCK SENSOR
POTENTIOMETER

 SELECT 

③ Connect the test leads as displayed by the test tool's Connection Help and shown in Figure 5-12.

④  Starts the Crankshaft Position Sensor test.

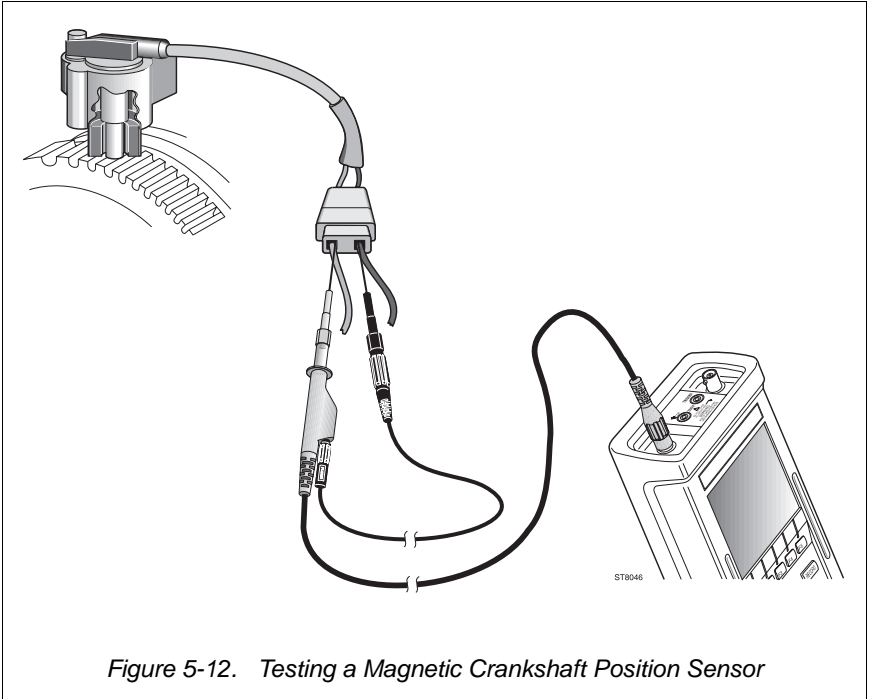

Figure 5-12. Testing a Magnetic Crankshaft Position Sensor

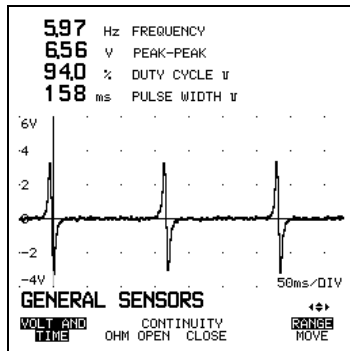
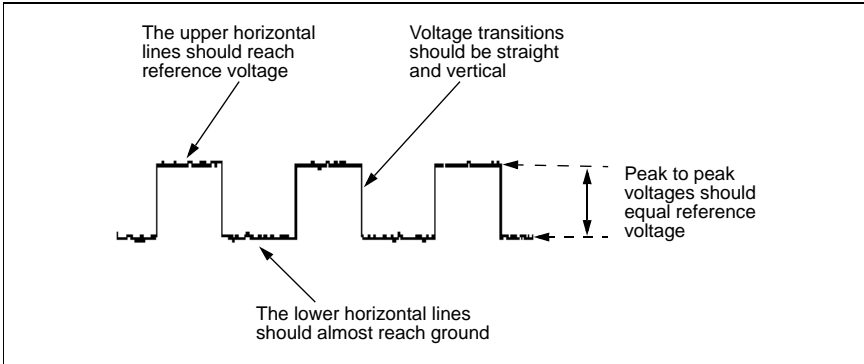
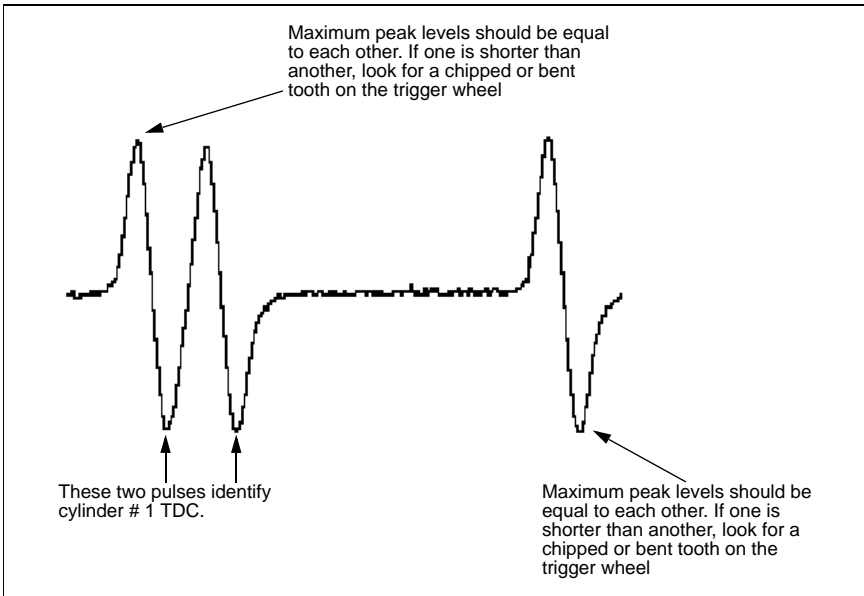

Figure 5-13. Result Display from a Magnetic Crankshaft Position Sensor Test

Crankshaft Position Sensor (Hall Effect)



Crankshaft Position Sensor (Magnetic)



Specifications may vary. Consult manufacturer's specifications.

Camshaft Position Sensor

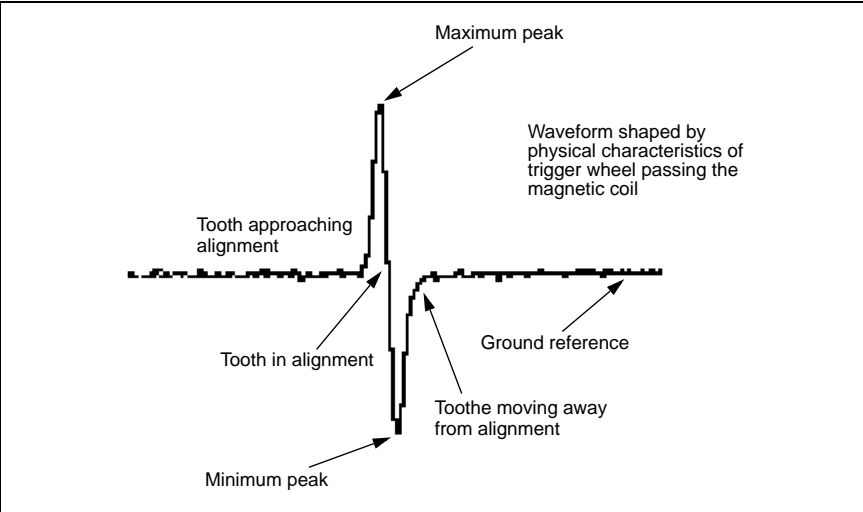

Specifications may vary. Consult manufacturer's specifications.

6 Ride Height (Position) — Potentiometer



Variable position sensors provide a dc voltage level that changes as the arm on a variable resistor (potentiometer) is moved. A ride height sensor is simply a variable resistor connected between the vehicle frame and the rear axle or inside the strut assembly. The changing dc voltage is used as an input to the electronic control unit to adjust ride height.

Some manufacturers use optical or hall-effect sensors. Use GENERAL SENSORS to test these types of sensors.

Measurement Conditions



- Turn the key ON, engine OFF. Backprobe the sensor's connector or use jumper wires. Disconnect the moveable arm of sensor (attached to the rear axle.) Move the arm from stop to stop to monitor the full
- Turn the key OFF, engine OFF. Test the sensor's resistance by carefully disconnecting the sensor from its associated wiring harness. Use the resistance mode to determine if there is an open or short in the potentiometer.
- Reconnect the movable arm to the rear axle and adjust the ride height sensor to the specifications found in the vehicle's service manual.

Test Tool Key Sequence

①   

MENU
SENSORS
AIR/FUEL
IGNITION
ELECTRICAL SYSTEM
SCOPE
MULTIMETER
VEHICLE DATA
INSTRUMENT SETUP

 SELECT F5

②  

SENSORS MENU
GENERAL SENSORS
OXYGEN SENSOR
DUAL OXYGEN SENSOR
TEMPERATURE SENSOR
KNOCK SENSOR
POTENTIOMETER

 SELECT F5

③ Connect the test leads as displayed by the test tool's Connection Help and shown in Figure 5-14.

④  Starts the sweep test.

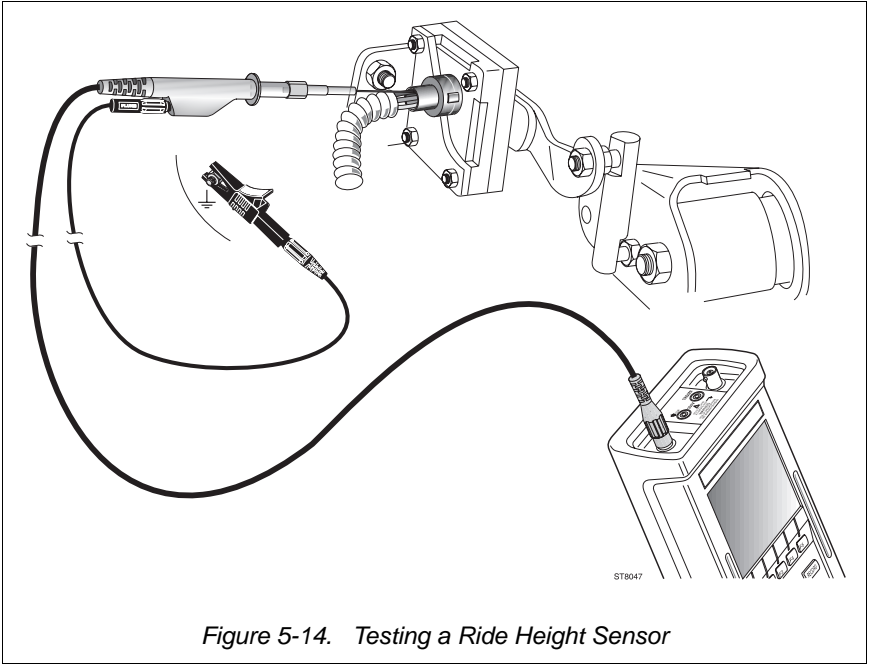

Figure 5-14. Testing a Ride Height Sensor

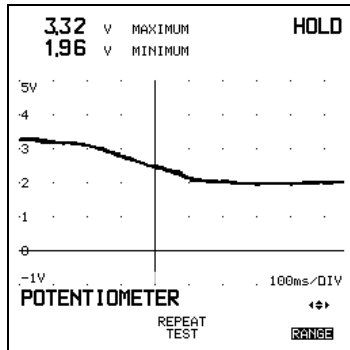
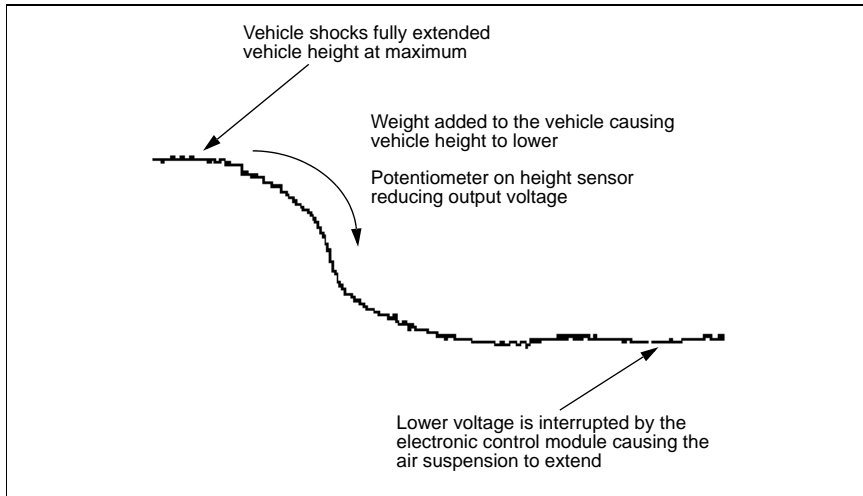

Figure 5-15. Result Display of a Voltage Test on a Ride Height Sensor

Ride Height Sensor



Specifications may vary. Consult manufacturer's specifications.

7 Vehicle Speed Sensor (VSS) — Magnetic, Hall-Effect, and Optical

The VSS output signal is directly proportional to vehicle speed. The ECU controls torque-converter clutch lockup, electronic transmission shift levels, and other functions from this signal. There are three main sensor types used for the Vehicle Speed Sensor, magnetic, Hall-effect, and optical.





Variable Reluctance Sensors (magnetic) do not require a separate power connection and have two connecting wires for the stationary magnet's coil. Small signal voltages are induced as the teeth of a trigger wheel, made of a low magnetic reluctance steel, pass through the magnetic field of a stationary magnet and coil.



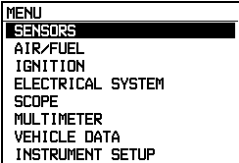

Optical sensors use a rotor disk that separates LEDs from optical pickups. Small openings, or slits, in the rotor disk, allow light from the LEDs to energize the optical pickups. Each time a slit aligns with the LEDs and optical pickups, the pickup sends out a pulse.

Measurement Conditions

- **Raise the drive wheels off the ground** and place the transmission in drive.
- Connect the test tool to the sensor according to the instruments Connection Help and start the engine.
- Monitor the VSS output signal at low speed while gradually increasing the speed of the drive wheels.

Test Tool Key Sequence

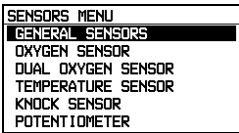
①    

②    

- ③ Connect the test leads as displayed by the test tool's Connection Help and shown in Figure 5-16.

④  Starts the Vehicle Speed Sensor test.

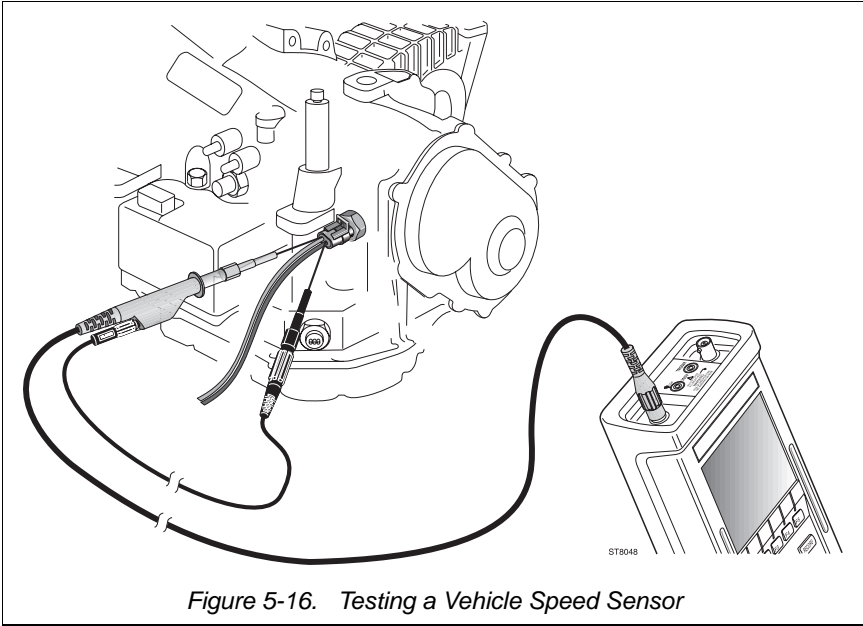

Figure 5-16. Testing a Vehicle Speed Sensor

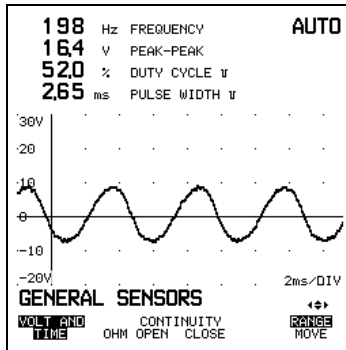

Figure 5-17. Result Display from a Magnetic Vehicle Speed Sensor Test

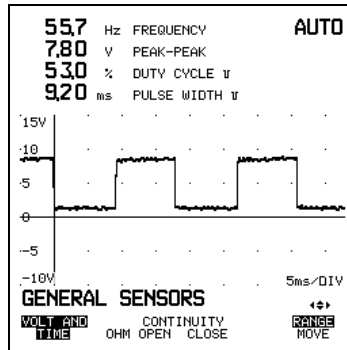

Figure 5-18. Result Display from a Hall-Effect Vehicle Speed Sensor Test

Vehicle Speed Sensor (Magnetic)

If the amplitude is low, look for an excessive air gap between the trigger wheel and the pickup.

If the amplitude waivers, look for a bent trigger wheel or shaft.

If one of the oscillations look distorted, look for a bent or damaged tooth on the trigger wheel.

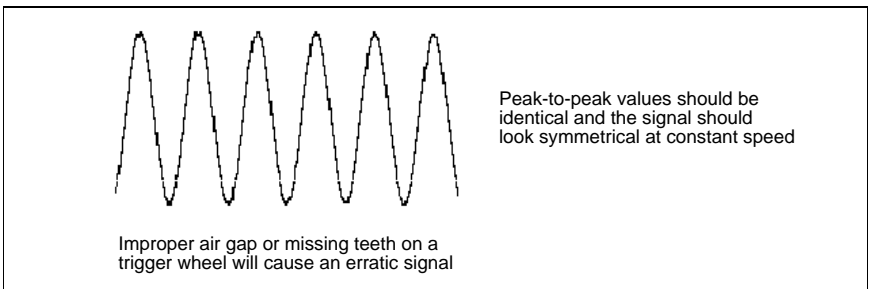

Vehicle Speed Sensor (Optical)

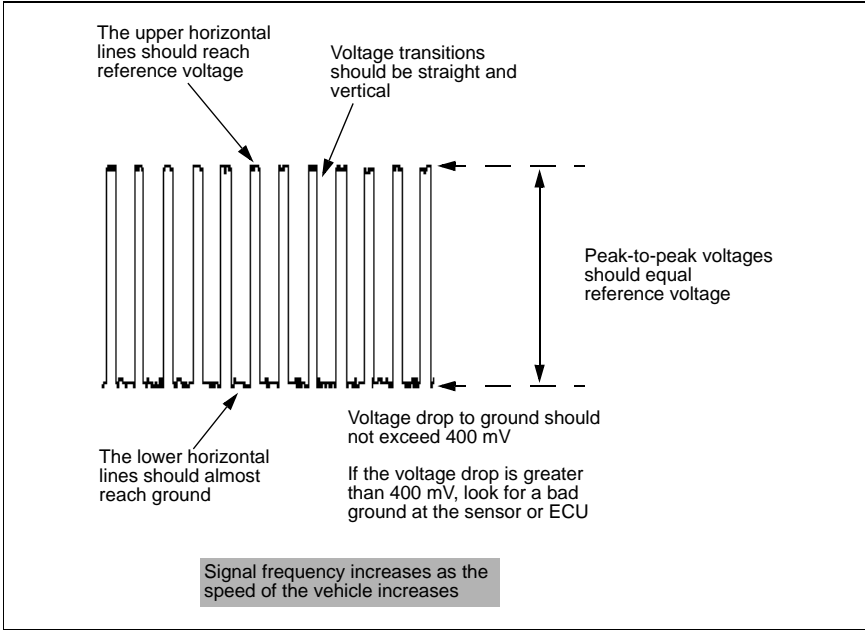

Specifications may vary. Consult manufacturer's specifications.

8 Anti-Lock Wheel Speed Sensor (ABS) — Magnetic

The ABS computer compares the frequencies, but not voltage levels, from magnetic wheel sensors, and uses this information to maintain wheel speeds while braking. The frequency is directly related to the wheel speed, and increases as the wheel speed increases.







Variable Reluctance Sensors do not require a separate power connection and have two connecting wires for the stationary magnet's coil. Small signal voltages are induced as the teeth of a trigger wheel, made of a low magnetic reluctance steel, pass through the magnetic field of a stationary magnet and coil.

Measurement Conditions

- ***Raise the vehicle off the ground.***
- Key OFF, Engine OFF. Disconnect the wheel speed sensor from the vehicle's wiring harness. Connect the test tool to the wheel speed sensor connector and rotate the wheel.

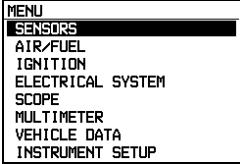
or
- Engine RUNNING. Back probe the connector leading to the wheel speed sensor (or use a breakout box.) Place the transmission in drive, and slowly accelerate the drive wheels. To test the non-drive wheels, use the procedure outlined above in Key OFF, Engine OFF.

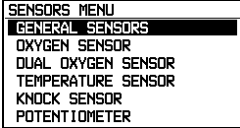
Test Tool Key Sequence

- ①    
- ②   
- ③ Connect the test leads as displayed by the test tool's Connection Help and shown in Figure 5-19.
- ④  Starts the ABS Wheel Speed Sensor test. (See Figure 5-19 and 5-20.)

Use the RECORD - PLOT READINGS function to monitor the sensor over time and find intermittents that can cause the MIL (Malfunction Indicator Lamp) to light.

Press the RECORD button.

Select PLOT READINGS and press F5 to Select.

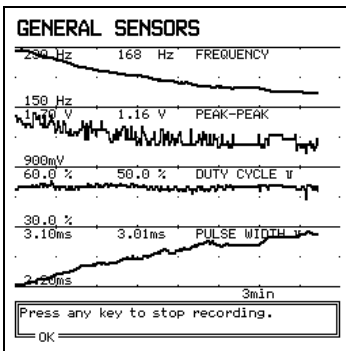

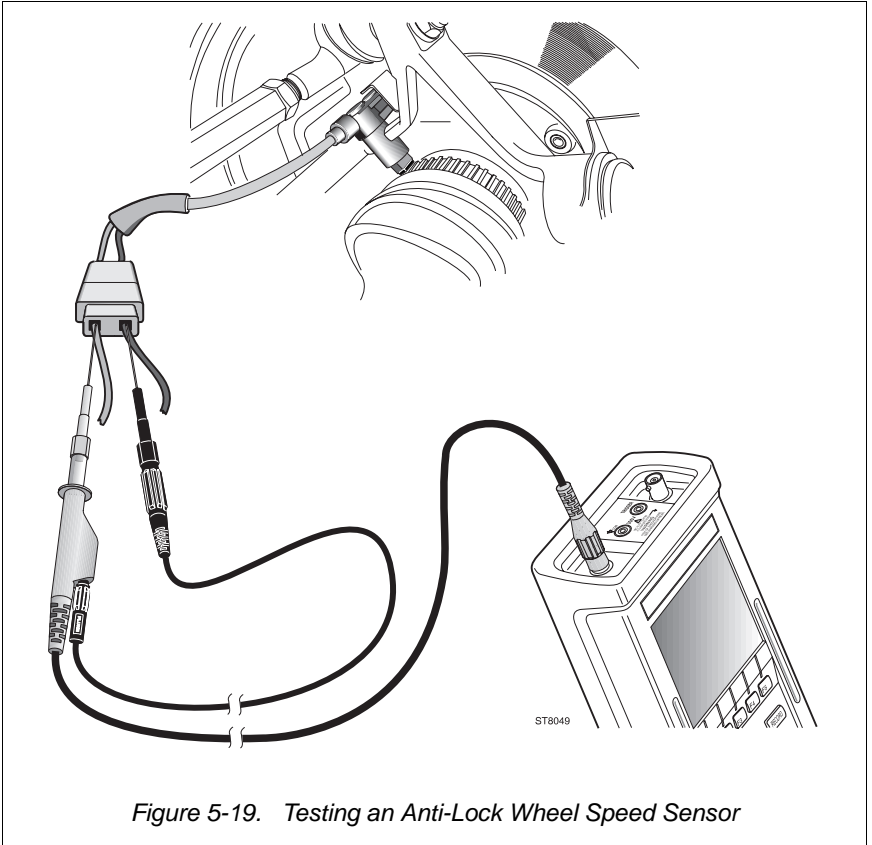

Figure 5-19. Testing an Anti-Lock Wheel Speed Sensor

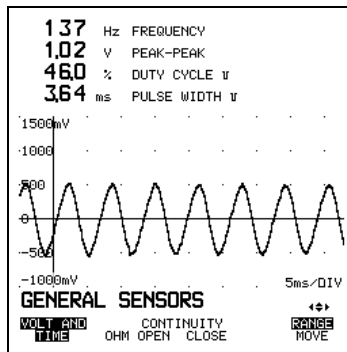

Figure 5-20. Result Display from an Anti-Lock Wheel Speed Sensor Test

Anti-Lock Wheel Speed Sensor Analysis

If the amplitude is low, look for an excessive air gap between the trigger wheel and the pickup.

If the amplitude wavers, look for a bent axle.

If one of the oscillations looks distorted, look for a bent or damaged tooth on the trigger wheel.

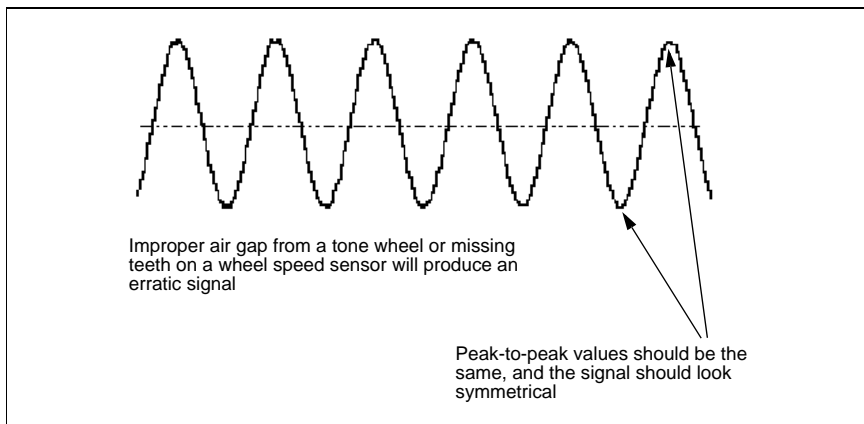

Specifications may vary. Consult manufacturer's specifications.

AIR/FUEL

9 Air Flow Sensors

Analog, Digital, and Potentiometer Sensors

ANALOG MASS AIR FLOW SENSOR (MAF)

This mass air flow sensor uses a heated-metal-foil sensing element to measure air flow entering the intake manifold. The sensing element is heated to a temperature of about 170°F (77°C), above the temperature of incoming air. As air flows over the sensing element, it cools the element, causing resistance to drop. This causes a corresponding increase in current flow, which causes supply voltage to decrease. This signal is seen by the ECU as a change in voltage drop, (an increase in air flow causes an increase in voltage drop), and is used as an indication of air flow.

DIGITAL MASS AIR FLOW SENSOR (MAF)

This type of air flow sensor receives a 5 volt reference signal from the electronic control unit and sends back a variable frequency signal that is equivalent to the mass of air entering the engine. The output signal is a square wave, with amplitude fixed at 0 and 5 volts. Frequency of the signal varies from about 30 to 150 Hz. Low frequency equals low air flow; high frequency equals high air flow.

AIR FLOW METER (Potentiometer)



Air-flow meters have a spring-loaded vane that pivots on a shaft as it opens and closes in response to a volume of incoming air. A variable resistor "potentiometer" is connected to the vane at its pivot point, causing the output voltage signal to change as the air vane angle changes. When the vane is wide open, the ECU knows that a maximum amount of air is being drawn into the engine, and when it is closed, a minimum amount of air is entering the engine. The ECU responds by increasing or decreasing fuel injector pulse width accordingly.

The electronic control units use these signals to calculate fuel injector pulse width or ON time and ignition timing. Engine coolant temperature, engine speed, manifold air temperature, and the air flow sensor signals enable the computer to make the necessary calculations and adjustments.

Measurement Conditions



- Connect the test tool to the output signal from the air flow sensor (or meter).
- Start the engine and allow the engine to idle. Slowly accelerate the engine while watching the display.
- Use a screwdriver handle and gently tap on the sensor while performing this test. Loose connections in the sensor can cause momentary hesitations and flat spots.

Test Tool Key Sequence for a Mass Air Flow Sensor Test

①   

MENU
SENSORS
AIR/FUEL
IGNITION
ELECTRICAL SYSTEM
SCOPE
MULTIMETER
VEHICLE DATA
INSTRUMENT SETUP



 SELECT 

②  

SENSORS MENU
GENERAL SENSORS
OXYGEN SENSOR
DUAL OXYGEN SENSOR
TEMPERATURE SENSOR
KNOCK SENSOR
POTENTIOMETER

 SELECT 

③ Connect the test leads as displayed by the test tool's Connection Help and shown in Figure 5-21.

④   Starts the Mass Air Flow Sensor test.
If necessary, use the arrow keys to range.

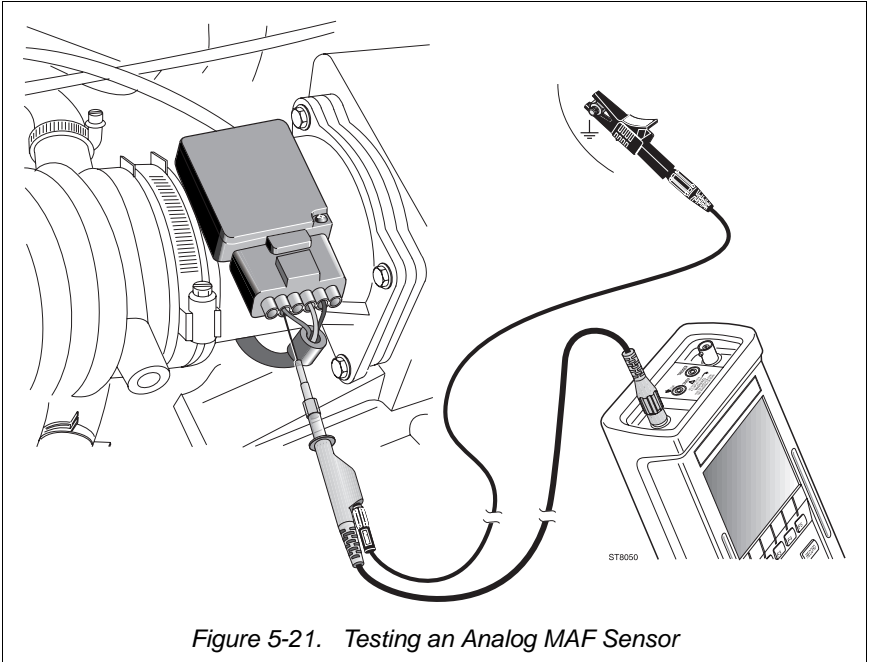

Figure 5-21. Testing an Analog MAF Sensor

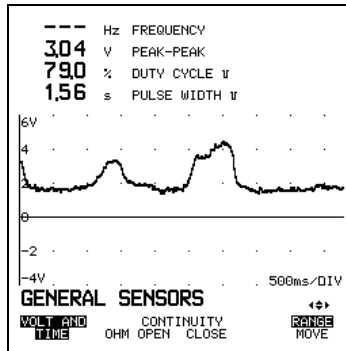

Figure 5-22. Result Display from an Analog MAF Sensor Test

INTERMITTENT RECORD is a powerful function to watch the signal over time. This function also gives you more time to activate the MAF Sensor and then stop recording. See the example for Oxygen Sensor on page 5-10.

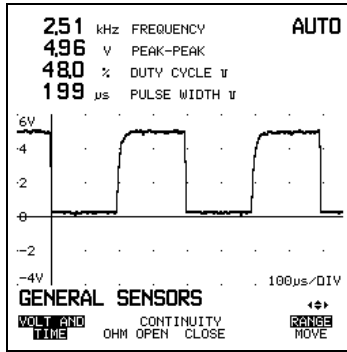
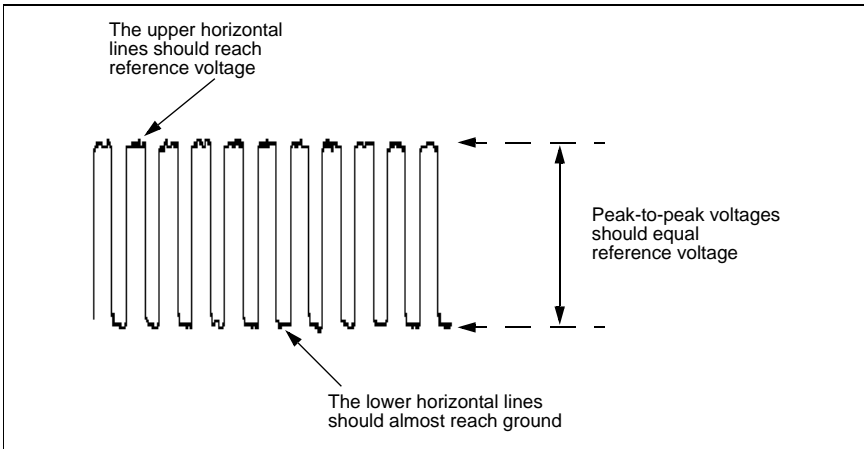

Figure 5-23. Result Display from a Digital MAF Sensor Test

Mass Air Flow Sensor (Digital)



Voltage drop to ground should not exceed 400 mV.

If the voltage drop is greater than 400 mV, look for a bad ground at the sensor or ECU.

Signal frequency increases as the air flow through the sensor increases.

Mass Air Flow Meter (Analog)

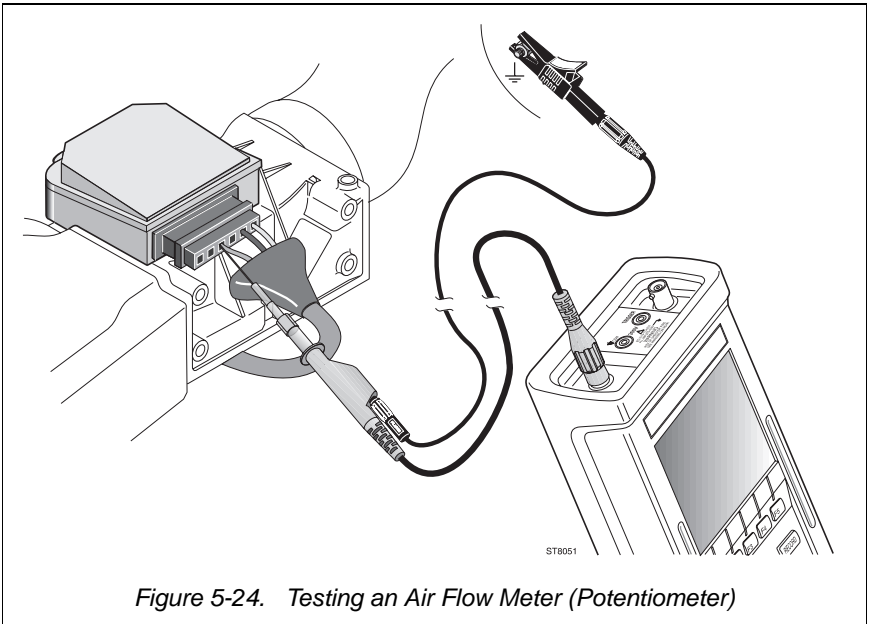
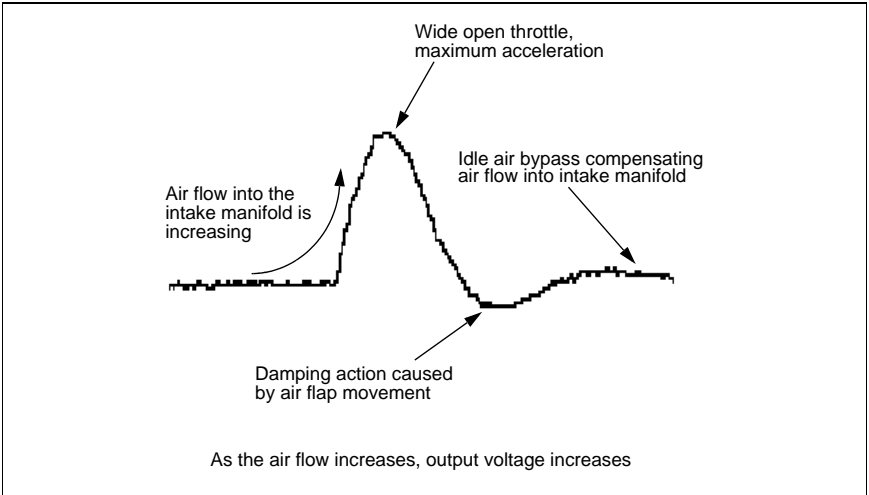

Specifications may vary. Consult manufacturer's specifications.

Use Potentiometer Sweep Test to test this volume Air Flow Meter (see page 5-15).

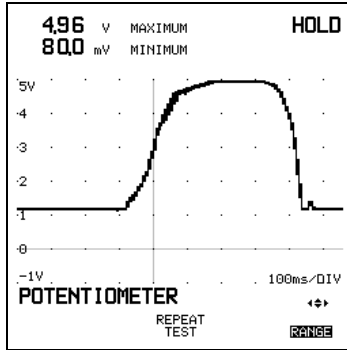
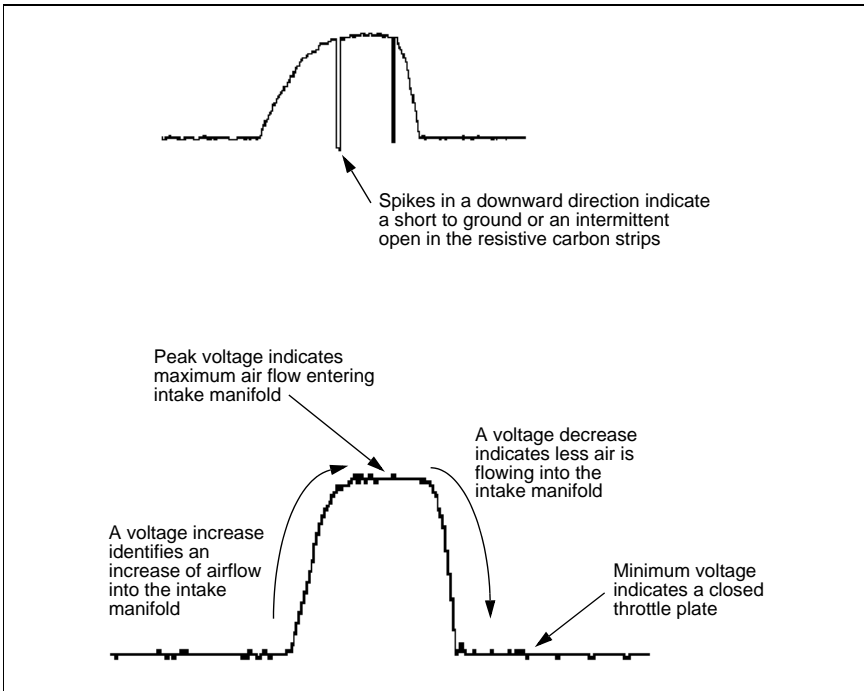

Figure 5-25. Result Display from a Volume Air Flow Meter Test

Air Flow Meter (Potentiometer)



Specifications may vary. Consult manufacturer's specifications.

10 Exhaust Gas Recirculation (EGR)

Pulse Width (Control) — Potentiometer (Sensor)

CONTROL

EGR dilutes the air-fuel mixture and limits NO_x formation when combustion temperatures are high and air-fuel ratios are lean. On a gasoline engine, EGR should operate during moderate acceleration and at cruising speeds from 30 to 70 mph (50 to 120 km/h).

The ECU controls the application of EGR by applying or blocking vacuum, providing a signal to de-energize or energize a solenoid, or by using a pulse-width-modulated solenoid.

SENSOR

Variable position sensors provide a dc voltage level that changes as the arm on a variable resistor (potentiometer) is moved. An EGR valve position sensor is simply a variable resistor connected to a plunger shaft that rides atop the EGR valve. The changing dc voltage is used as an input to the electronic control unit to indicate EGR operation.

Measurement Conditions

Control

- Engine RUNNING. With the test tool connected to the EGR valve, slowly increase engine speed to cruise speed.



NOTE: Most EGR valves will not open until the engine is placed under load. For this reason a road test or dyno may be necessary.

Sensor

CAUTION: Perform the following tests on a cold engine to prevent personal injury.



- Key ON, Engine OFF. Back probe the position sensor on top of the EGR valve and carefully (with a cold engine), raise the EGR from its seat position. If there is limited or no access to the EGR diaphragm, running the vehicle under a load may be necessary to move the EGR valve.
- Key OFF, Engine OFF. Disconnect the sensor from the engine wiring harness and carefully raise the EGR from its seated position. Some position sensors can be separated from the EGR valve to allow access to the sensor plunger.
- To test the position sensor, use POTENTIOMETER SWEEP TEST under GENERAL SENSORS

Test Tool Key Sequence

- ①   

MENU
SENSORS
AIR/FUEL
IGNITION
ELECTRICAL SYSTEM
SCOPE
MULTIMETER
VEHICLE DATA
INSTRUMENT SETUP



 SELECT 

- ②  

SENSORS MENU
GENERAL SENSORS
OXYGEN SENSOR
DUAL OXYGEN SENSOR
TEMPERATURE SENSOR
KNOCK SENSOR
POTENTIOMETER

 SELECT 

- ③ Connect the test leads as displayed by the test tool's Connection Help and shown in Figure 5-26.

- ④   Starts the EGR test.

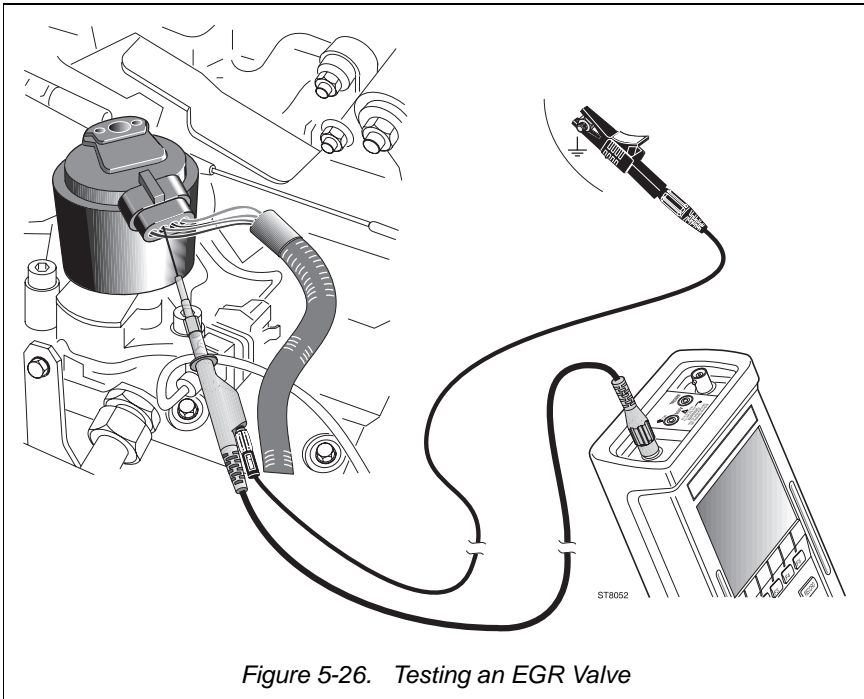

Figure 5-26. Testing an EGR Valve

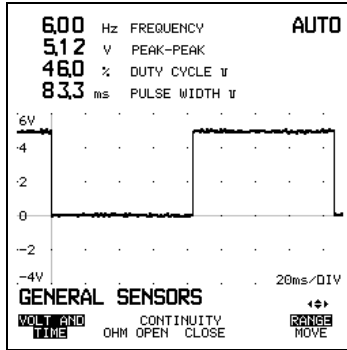
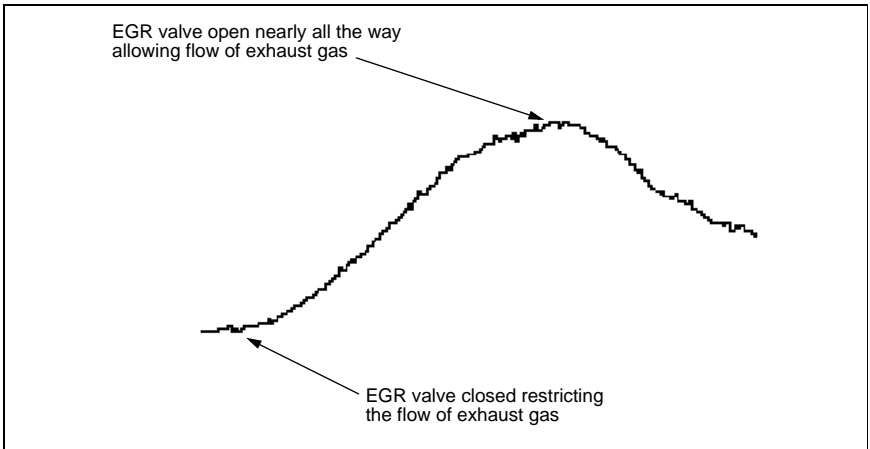

Figure 5-27. Result Display from an EGR Valve Test

Exhaust Gas Recirculation (EGR) valve Position Sensor



Specifications may vary. Consult manufacturer's specifications.

11 Fuel Injection (FI)

Current Controlled (Peak and Hold) including Throttle Body Injection (TBI), Conventional (Saturated Switch), and Pulse Width Modulated Injectors

Electronic fuel injectors are controlled by the ECU and influenced by a variety of operating conditions including temperature, engine load, and feedback from the O₂ sensor during closed loop operation.

Fuel injection on-time can be expressed in ms pulse width and indicates the amount of fuel delivered to the cylinder. Greater pulse width means more fuel, provided the fuel pressure stays the same.

The ECU provides a ground path for the injector through a driver transistor.

When the transistor is "on", current flows through the injector winding and the transistor to ground, opening the injector valve.

There are three main fuel injector systems, each with its own method for controlling fuel injection. All injectors have some method for limiting the electrical flow through the injector — too much current flow could burn out the injector.

Current Controlled (Peak and Hold)

Peak and Hold injector circuits actually use two circuits to energize the injectors. Both circuits come on to energize the injector, this sends a high initial current to the injector, allowing it to open quickly.

Then, after the injector opens, one circuit releases, leaving the second circuit to hold the injector open through the duration of its on time. This circuit adds a resistance to the circuit, to reduce the current flow through the injector.

When the second circuit shuts off, the injector closes, ending the injector's on time. To measure on-time, look for the falling edge of the on-time pulse, and the second rising edge, which indicates where the second circuit shut off.

Throttle Body Injection (TBI)

The throttle body assembly was designed to replace the carburetor. The pulse width represents the amount of time the injector is energized or *ON*. The pulse width is varied by the ECU in response to changes in engine operation and driving conditions.

Conventional (Saturated Switch)

The injector driver transistor applies constant current to the injector. Some injectors use a resistor to limit the current flow; others have a high internal resistance. These injectors have a single rising edge.



Pulse Width Modulated Injectors

Pulse modulated injectors have a high initial current applied to energize the injector quickly. Then, after the injector is open, the ground begins pulsing on and off to extend injector on time, while limiting the current applied to the injector.

Measurement Conditions

- Engine RUNNING after you have connected the test tool to the ground side of the fuel injector by using a back probe, jumper wire, or breakout box. Begin the test with the engine idling, and slowly increase engine speed while monitoring the injector signal.
- Increase engine load by varying the MAP sensor signal or by changing the output signal from the oxygen sensor.
- One method is to disconnect the oxygen sensor from its harness and ground the lead (harness side.) This will cause the voltage signal going to the ECU to decrease. The ECU will respond by widening the injector pulse width. However, this method may set an error code.
- Hold the harness connector in one hand and touch the + (positive) side of the battery. This will cause an increase in oxygen sensor signal voltage going to the ECU. The ECU will respond by narrowing the pulse width of the fuel injector.



Test Tool Key Sequence

- ① 
- ② 

MENU
SENSORS
AIR/FUEL
IGNITION
ELECTRICAL SYSTEM
SCOPE
MULTIMETER
VEHICLE DATA
INSTRUMENT SETUP

- ③

AIR/FUEL MENU
FUEL INJECTOR
POTENTIOMETER
STEPPER MOTOR
OXYGEN SENSOR
DUAL OXYGEN SENSOR
GENERAL SENSORS

- ④ Connect the test leads as displayed by the test tool's Connection Help and shown in Figure 5-28.
- ⑤  Starts the Fuel Injector test.

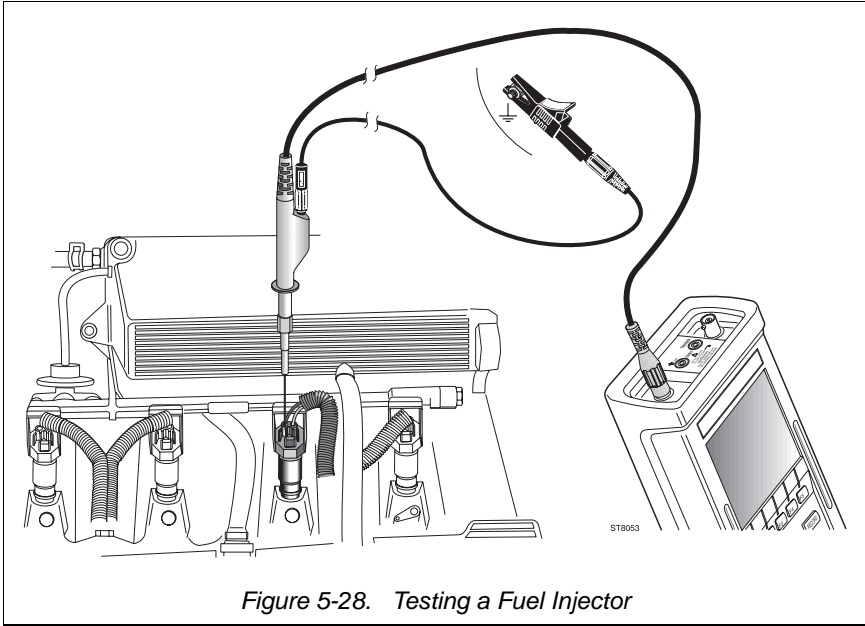

Figure 5-28. Testing a Fuel Injector

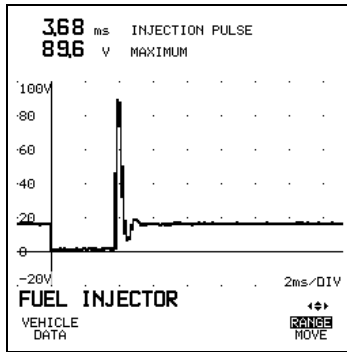
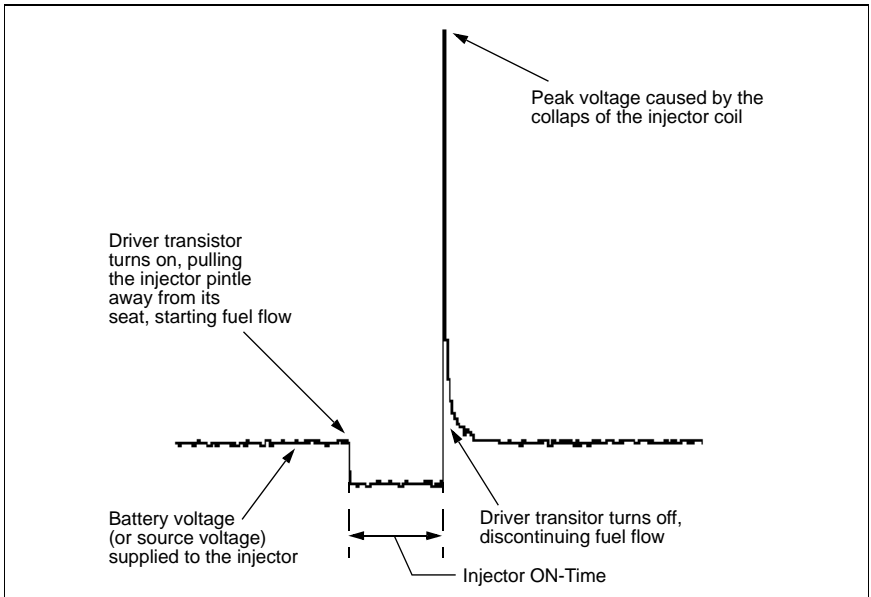

Figure 5-29. Result Display from a Fuel Injector Test

Conventional (Saturated Switch Driver) Fuel Injector



Specifications may vary. Consult manufacturer's specifications.

Pulse-Width Modulated Fuel Injector

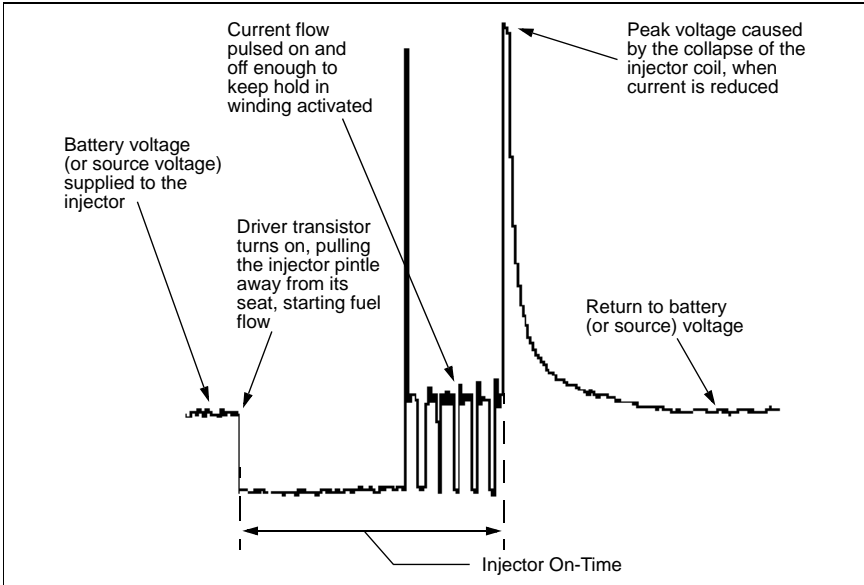

Specifications may vary. Consult manufacturer's specifications.

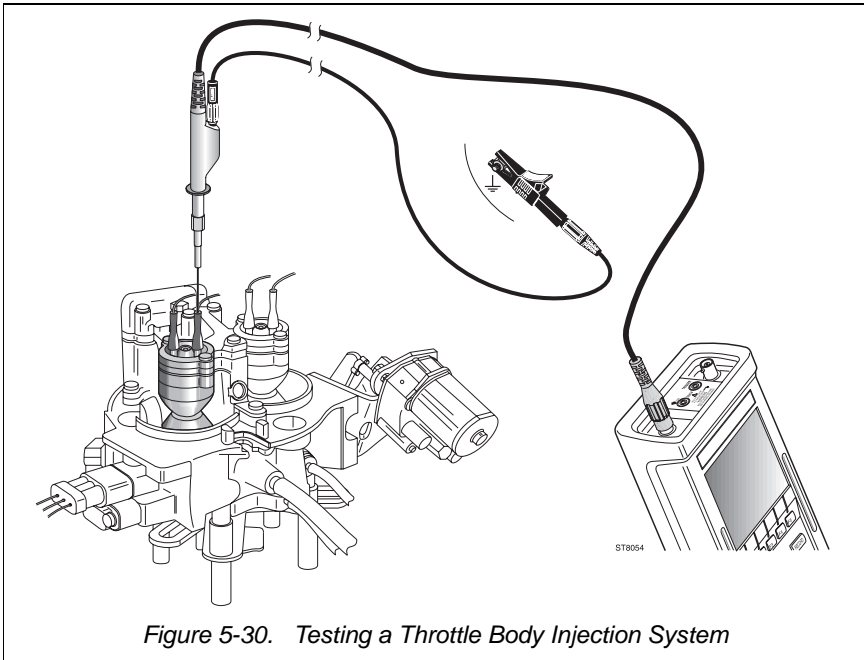
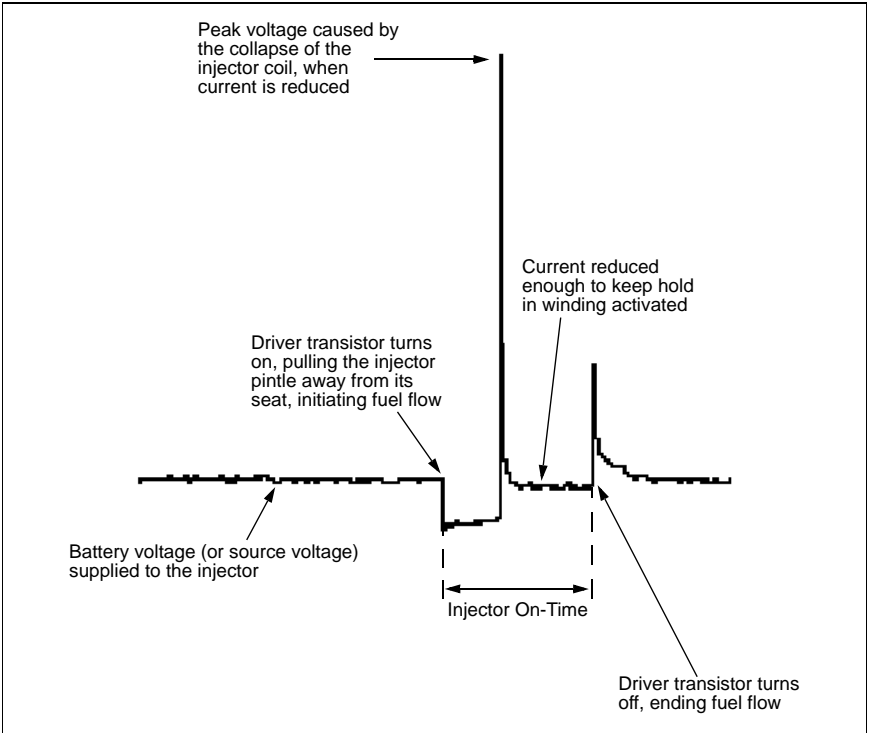

Figure 5-30. Testing a Throttle Body Injection System

Current-Controlled (peak and Hold) Fuel Injector (Throttle Body and Port Fuel Injection Systems)



Specifications may vary. Consult manufacturer's specifications.

12 Mixture Control Solenoid (MC) (Pulse Width





Computer controlled systems use a mixture control solenoid and stepper motor to control fuel metering, along with throttle position sensors and oxygen sensors which help control injection times by sending signals back to the ECU. The MC solenoid is duty cycled by a solid-state grounding switch in the ECU. When the solenoid is activated, metering rods are forced downward restricting fuel flow. When the ECU opens the circuit, the restriction in the main metering system is removed, thus providing a rich mixture.



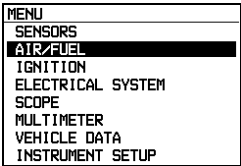

Measurement Conditions

- Engine RUNNING after you have connected the test tool to the mixture-control solenoid by using a back probe or jumper wire. (Some vehicles have a pigtail harness near the solenoid for ease of connection.) Insure that the engine management system is under fuel control (pulse width varying) and that the engine is in closed loop.
- Create a large vacuum leak (brake booster), and watch the signal change as the ECU enriches the mixture to compensate for the vacuum leak.
- Close the choke or use propane enrichment to enrich the mixture. Watch the signal change as the ECU compensates for the lack of oxygen at the oxygen sensor.

Test Tool Key Sequence

① 

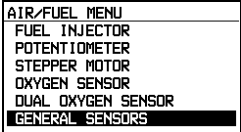
②    

③    

④ Connect the test leads as displayed by the test tool's Connection Help and shown in Figure 5-31.

⑤  Starts the Mixture Control test.

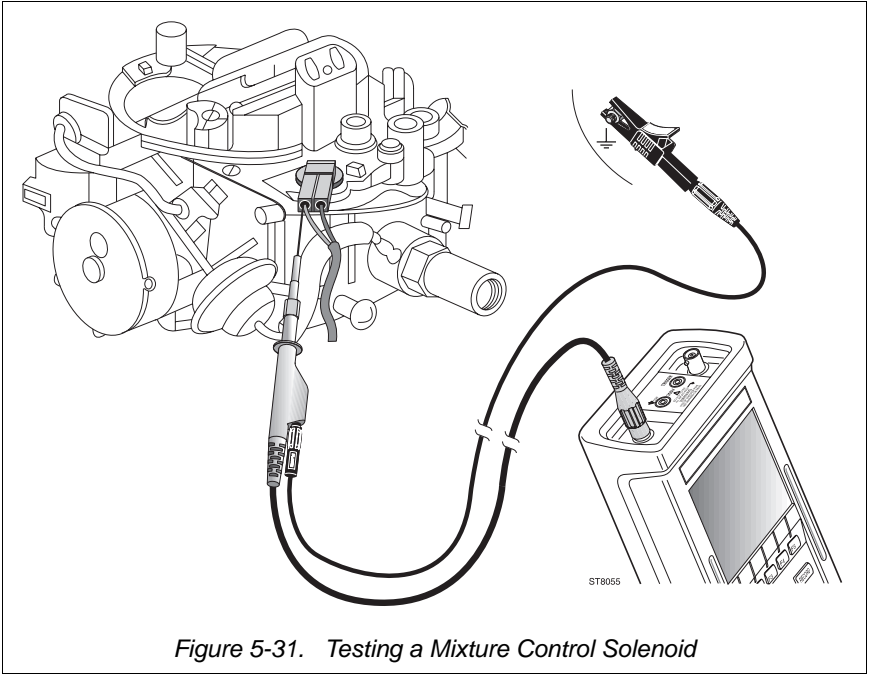

Figure 5-31. Testing a Mixture Control Solenoid

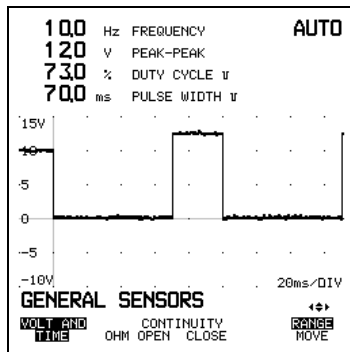

Figure 5-32. Result Display from a Mixture Control Solenoid Test

13 Idle Air Control / Idle Speed Control (IAC/ISC)



Duty Cycle and Voltage

The idle air control (IAC) is controlled by the ECU to regulate or adjust engine idle speed and prevent stalling. Some idle air-control systems use a stepper motor to control the amount of air allowed to bypass the throttle plate, and others use a bypass valve that receives a square wave signal from the ECU. Due to solenoid reactance, this signal may be shaped differently.

Measurement Conditions



- Engine RUNNING after you have connected the test tool to the Idle Air Control valve. Monitor the valve's operation with the engine cold, warming up, and hot.
- Introduce a small vacuum (false air) leak, and watch the signal from the ECU as it adjusts the valve's opening.

Test Tool Key Sequence

①   

MENU
SENSORS
AIR/FUEL
IGNITION
ELECTRICAL SYSTEM
SCOPE
MULTIMETER
VEHICLE DATA
INSTRUMENT SETUP



 SELECT

②  

AIR/FUEL MENU
FUEL INJECTOR
POTENTIOMETER
STEPPER MOTOR
OXYGEN SENSOR
DUAL OXYGEN SENSOR
GENERAL SENSORS

 SELECT

③ Connect the test leads as displayed by the test tool's Connection Help and shown in Figure 5-33.

④   Starts the Idle Air Control test.

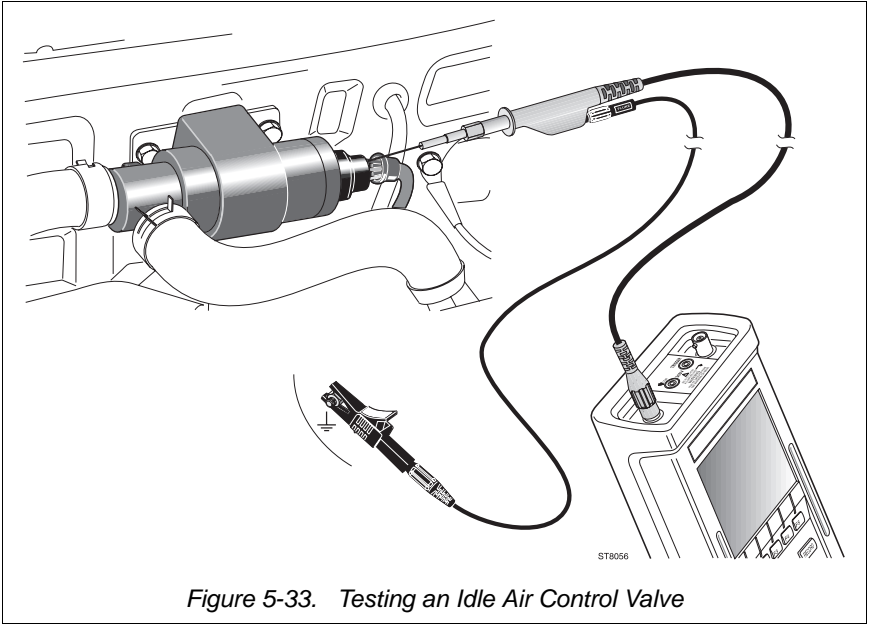

Figure 5-33. Testing an Idle Air Control Valve

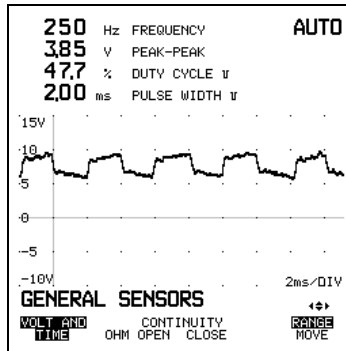
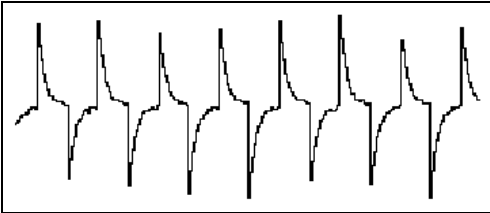
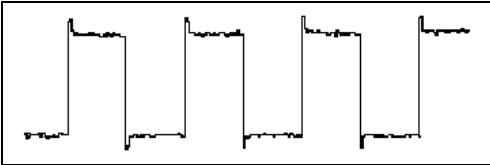

Figure 5-34. Result Display from an Idle Air Control Valve Test

Idle Air Compensation Valves



Idle Air Bypass waveforms may have unique shapes such as these and have a saw-curved appearance due to inductance reactance.

Specifications may vary. Consult manufacturer's specifications.

IGNITION

14 Knock Sensor — Piezo Crystal (Burst Pattern)

To optimize performance and fuel economy, ignition timing should be adjusted so that combustion occurs during a specific number of degrees of crankshaft rotation, beginning at TDC of the power stroke. If ignition occurs later, less power is produced by that cylinder, and if it occurs too soon, detonation will occur.

Most knock sensors contain a piezoelectric crystal that is screwed into the engine block. This is a special type of crystal that generates a voltage when it is subjected to mechanical stress. The crystal produces an electrical signal that has a unique signature based on the knock condition.

The output voltage is used by the ECU to adjust ignition timing to optimize engine performance.

Measurement Conditions



Out-Of-Circuit Test (Sensor Disconnected)

- Disconnect the knock sensor from the vehicle's wiring harness. Connect the test tool to the sensor.
- Use a small mallet and gently tap the engine block near the sensor to generate a signal.

In-Circuit Test of the Knock Sensor (Retarding Test)



- Perform the Timing Advance test as described in Application #19.
- Use a small mallet and gently tap the engine block near the sensor to activate the knock sensor.
- Watch the ignition timing to insure that the timing retards as a knock signal is received by the ECU.

Test Tool Key Sequence for the Out-of-circuit Knock Sensor Test

- ①   

MENU
SENSORS
AIR/FUEL
IGNITION
ELECTRICAL SYSTEM
SCOPE
MULTIMETER
VEHICLE DATA
INSTRUMENT SETUP

 SELECT 

- ②  

SENSORS MENU
GENERAL SENSORS
OXYGEN SENSOR
DUAL OXYGEN SENSOR
TEMPERATURE SENSOR
KNOCK SENSOR
POTENTIOMETER

 SELECT 

- ③ Connect the test leads as displayed by the test tool's Connection Help and shown in Figure 5-35.

- ④  Starts the Knock Sensor test.
If necessary, use the arrow keys to adjust the range, and press F3 to repeat the test.

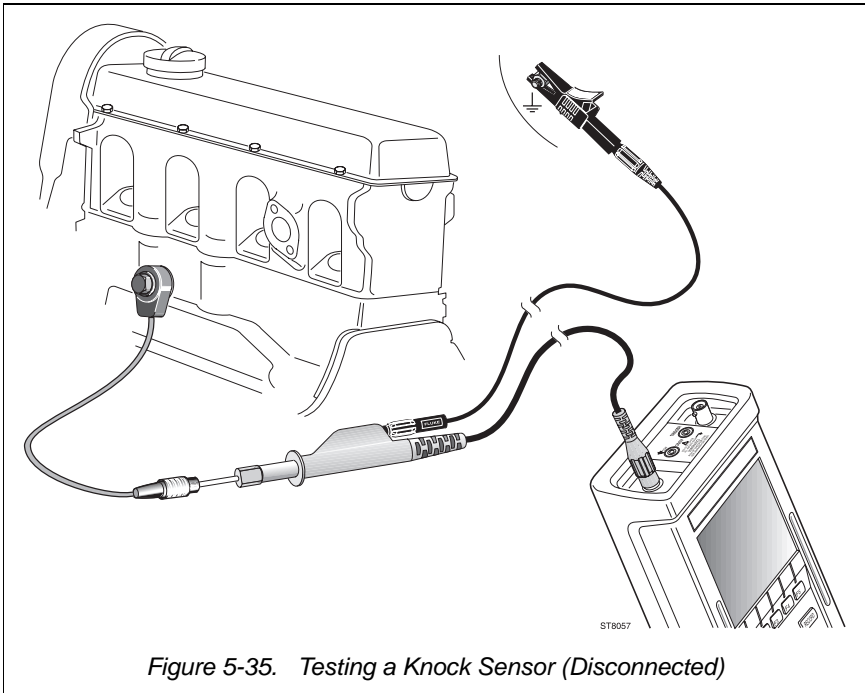

Figure 5-35. Testing a Knock Sensor (Disconnected)

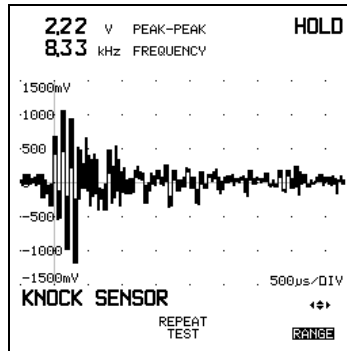
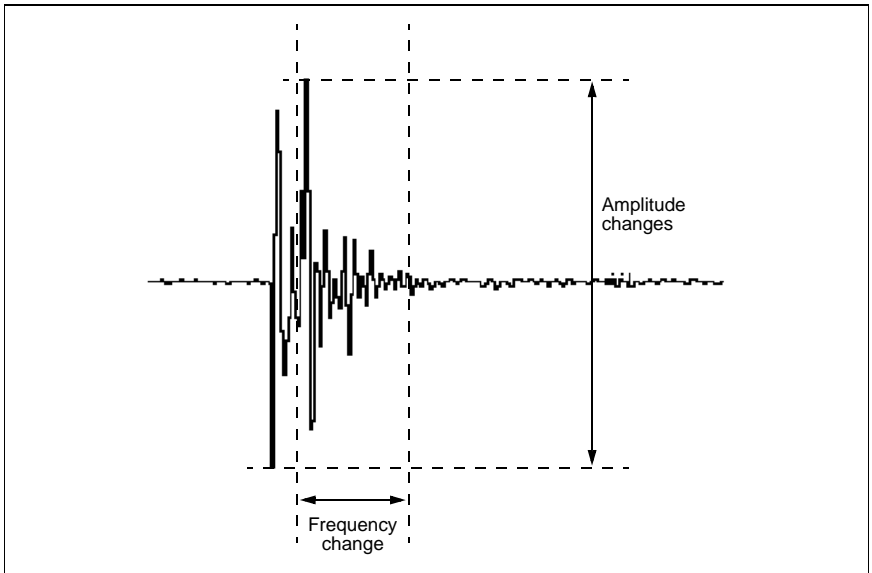

Figure 5-36. Result Display from a Knock Sensor Test

Knock Sensor



The pattern from this sensor is directly related to the cause and severity of the knock. For this reason each signal looks slightly different.

The main thing is to check for the presence of a signal.

On most vehicles, when the ECU receives a knock signal from the knock sensor, it retards ignition timing until the knock disappears.

Specifications may vary. Consult manufacturer's specifications.

15 Secondary Ignition

Conventional Single, Conventional Parade, and DIS Single

Secondary ignition patterns are useful when diagnosing ignition related malfunctions.

The secondary scope pattern is divided into three sections:

1. Firing
2. Intermediate
3. Dwell
4. Observe these sections during diagnosis.

SECONDARY FIRING SECTION

The firing section has a firing line and a spark line. The firing line is a vertical line that represents the voltage required to overcome the gap of the spark plug. The spark line is a semi-horizontal line that represents the voltage required to maintain current flow across the spark gap.

SECONDARY INTERMEDIATE SECTION

The intermediate section displays the remaining coil energy as it dissipates itself by oscillating between the primary and secondary side of the coil (with the points open or transistor off).

SECONDARY DWELL SECTION

The dwell section represents coil saturation, which is the period of time the points are closed or the transistor is ON.

When PARADE is selected, the Fluke 98 will present a parade of all the cylinders, starting at the left with the spark line of the number 1 cylinder. The scope will display the pattern for each cylinder's ignition cycle in the engine's firing order. For example: if the firing order for a given engine is 1,4,3,2, the scope will display the ignition cycles for each cylinder as shown starting with cylinder number 1, then 4, then 3, and then 2.











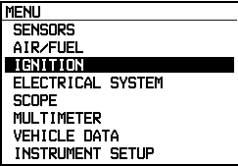

DISTRIBUTORLESS IGNITION SYSTEM (DIS) Single

Most distributorless ignition systems use a waste spark method of spark distribution. Each cylinder is paired with the cylinder opposite to it (1-4, or 3-6, or 2-5). The spark occurs simultaneously in the cylinder coming up on the compression stroke and in the cylinder coming up on the exhaust stroke. The cylinder on the exhaust stroke requires very little of the available energy to fire the spark plug. The remaining energy is used as required by the cylinder on the compression stroke. The same process is repeated when the cylinders reverse roles.

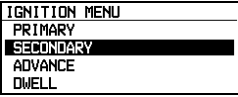

Measurement Conditions

- Follow the test tool's instructions for probe selection and connection information.
- Engine RUNNING. Test the ignition system under varying load and speed conditions to verify component integrity. Spark plugs, ignition wires, and other secondary ignition components may fail when a high demand is present. Run these tests under load (on a dyno or road test) to accurately determine system malfunctions.



Test Tool Key Sequence

- ①   At power on, check the settings in the VEHICLE DATA MENU. The following steps (2 to 9) describe the procedure for a conventional ignition system (IGNITION: CONV).
- ②  Press this key if the Vehicle Data are correct.
- ③     SELECT
- ④     SELECT
- ⑤ Connect the test leads as displayed by the test tool's Connection Help and shown in Figure 5-37. The Inductive Pickup must be clamped on the spark plug wire **close** to the spark plug.
- ⑥   Starts the Secondary Ignition tests.



If you want to test SECONDARY IGNITION SINGLE, do the following:

- ⑦  Press to highlight SINGLE.
F3
- ⑧ Connect the test leads as displayed by the test tool's Connection Help and shown in Figure 5-37. The Inductive Pickup must be clamped on the spark plug wire **close** to the spark plug.
- ⑨  Starts the SINGLE Secondary Ignition test.





If you want to test SECONDARY IGNITION on a DIS, you have to setup the test tool as follows (assumed that you are in the secondary ignition test already):

- ⑦  F1
- ⑧  

VEHICLE DATA MENU	
CYLINDERS	:4
CYCLES	:4
BATTERY	:12V
IGNITION	:CONV

 SELECT
F5
- ⑨  

CONV	▲
DIS	█
COP	▾
DIESEL	▾

 SELECT
F5
- ⑩   Selects DIS as the default ignition system.
- ⑪ Repeat steps ③ and ④ to re-select INGITION → SECONDARY.
- ⑫ Connect the test leads as displayed by the test tool's Connection Help and shown in Figure 5-39 and Figure 5-41.
- ⑬   Starts the Secondary Ignition (DIS) test.

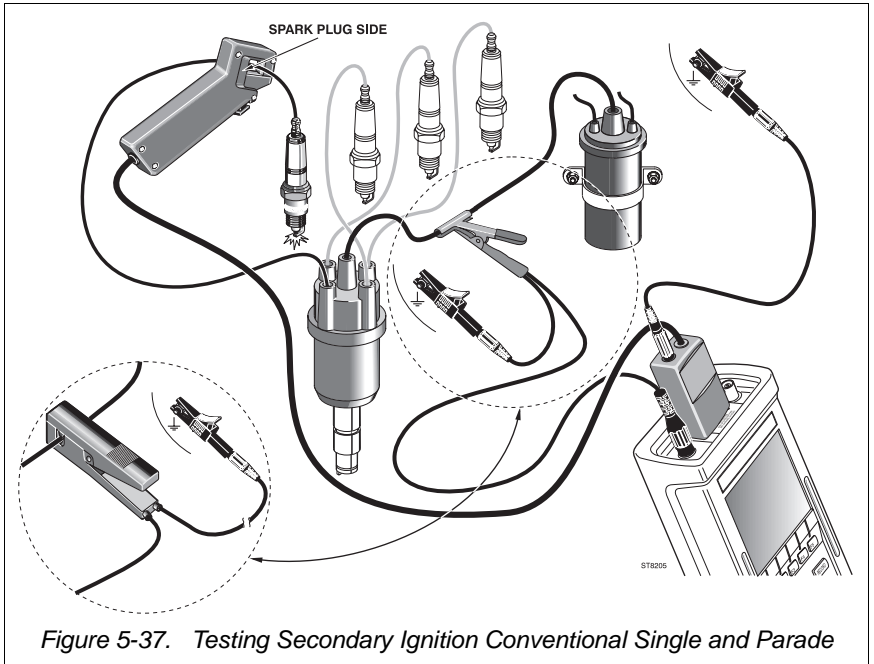
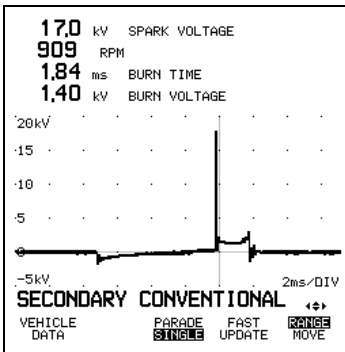
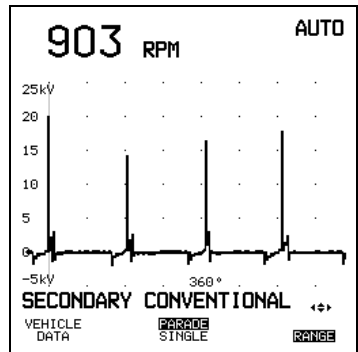

Figure 5-37. Testing Secondary Ignition Conventional Single and Parade



SINGLE Cylinder Display



PARADE Display

Figure 5-38. Result Display from Secondary Ignition Conventional

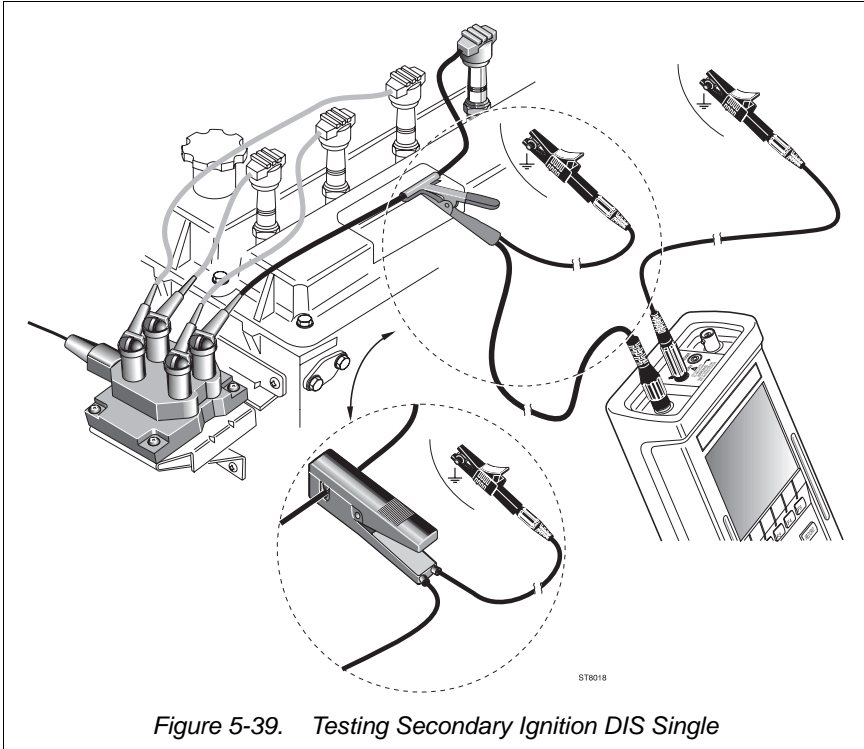
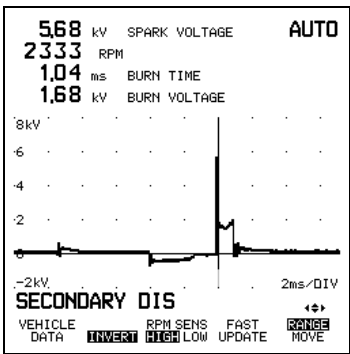

Figure 5-39. Testing Secondary Ignition DIS Single



Use the F3 key to set the optimal RPM SENSitivity level:

- Set RPM SENS LOW if the RPM reading is clearly too high, due to a high noise level.
- Set RPM SENS HIGH (common setting) when the RPM reading gets unstable, most likely under high load and high RPM conditions.

Figure 5-40. Result Display from Secondary Ignition DIS Single

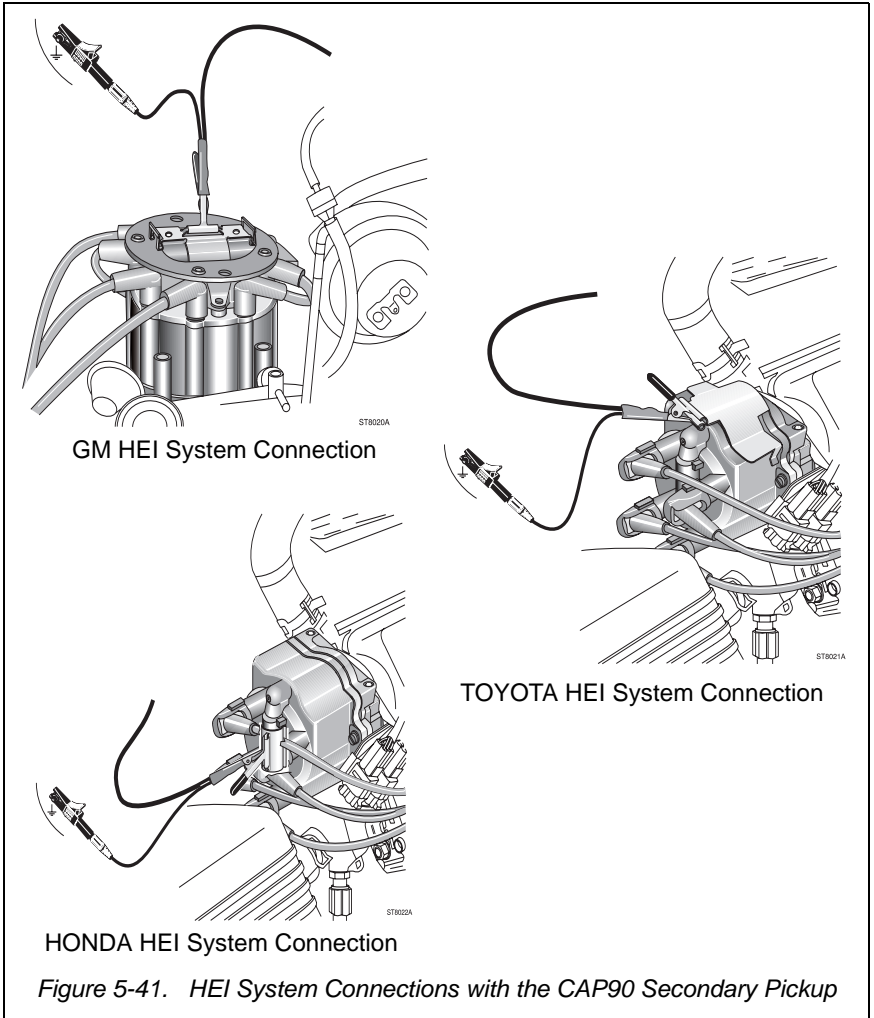

Secondary Conventional (Single)

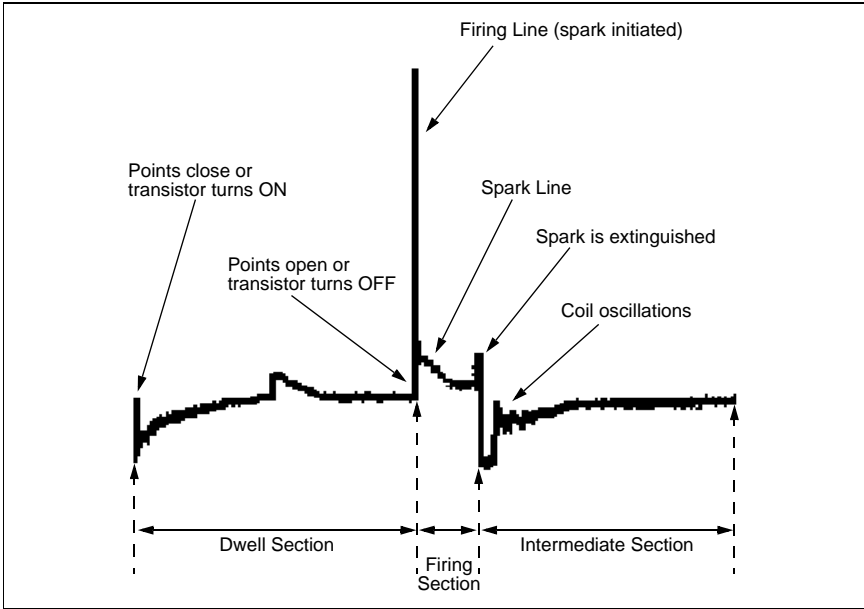

Secondary Conventional (Parade)

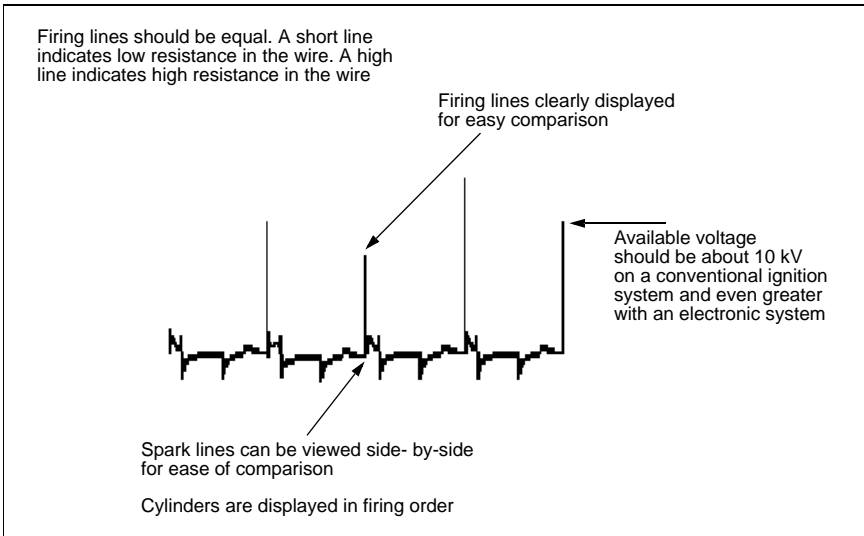

Specifications may vary. Consult manufacturer's specifications.

16 Primary Ignition

DWELL



Each time the breaker points or transistor opens, the coil secondary winding discharges high voltage to a spark plug. When closed, the points or transistor allow magnetic saturation to develop in the coil. The distributor, or ignition, dwell angle is the number of degrees of distributor rotation during which the points or transistor are closed (or magnetic saturation time in degrees).

It normally takes about 10 to 15 milliseconds (.010 to .015 second) for an ignition coil to develop complete magnetic saturation from primary current.



Measurement Conditions

- Follow the test tool's instructions for probe selection and connection information.
- Engine RUNNING. Test the ignition system under varying load conditions to verify component integrity. Primary ignition modules tend to fail under high demand and temperature conditions.



Test Tool Key Sequence

- 
- 

MENU
SENSORS
AIR/FUEL
IGNITION
ELECTRICAL SYSTEM
SCOPE
MULTIMETER
VEHICLE DATA
INSTRUMENT SETUP

- 

IGNITION MENU
PRIMARY
SECONDARY
ADVANCE
DWELL

- Connect the test leads as displayed by the test tool's Connection Help and shown in Figure 5-42.
- 

Starts the dwell test.

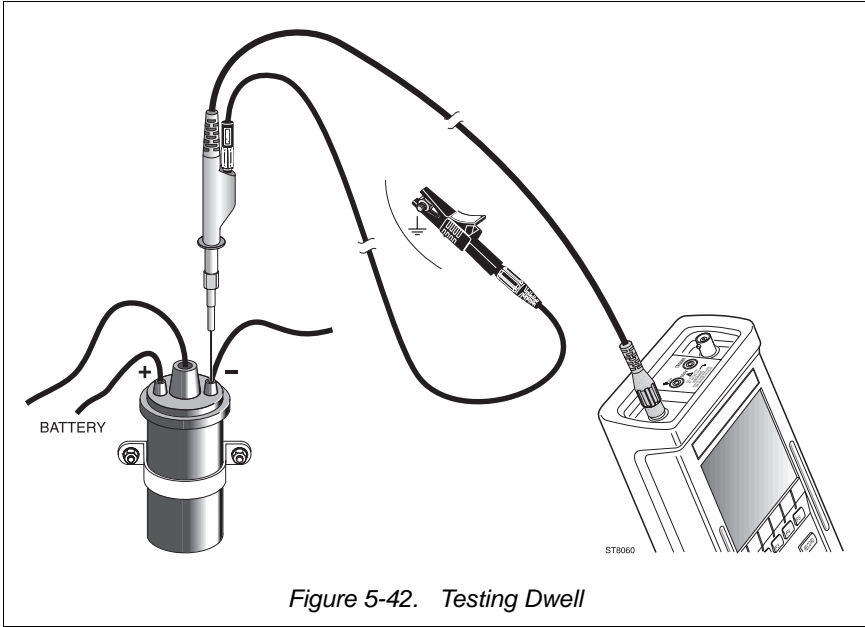

Figure 5-42. Testing Dwell

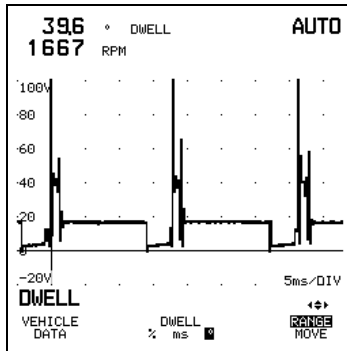

Figure 5-43. Result Display from a Dwell Test

17 Distributor Triggering

Magnetic, Hall-Effect, and Optical Triggering Devices

MAGNETIC DISTRIBUTOR TRIGGERING

Magnetic sensors used for distributor triggering have a permanent magnet and a pole piece. Fine wire is wrapped around the pole piece to form a pickup coil. A non-magnetic trigger wheel is attached to the distributor shaft and has as many teeth as the engine has cylinders. As a tooth of the trigger wheel passes through the magnetic field (built up around the pickup coil), a signal is generated. Magnetic, or variable reluctance sensors, typically have only two wires and generate their own signal voltage.

HALL-EFFECT DISTRIBUTOR TRIGGERING

A Hall-effect switch has a stationary sensor and a rotating trigger wheel and requires a small input voltage to generate an output voltage. When a shutter blade enters the gap between the magnet and the Hall element, the output voltage changes. This signal is sent as a square wave to the ignition module to trigger the coil.



OPTICAL DISTRIBUTOR TRIGGERING

An optical signal alternator uses the light from a light-emitting diode (LED) to strike a photo transistor and generate a voltage signal. The trigger wheel is a slotted disc that passes between the LED and the photo transistor.

Measurement Conditions



- If you are diagnosing a NO START CONDITION, connect the test tool as described in the test tool's Connection Help and crank the engine. Look for presence of a signal. If there is a signal, the problem is somewhere else. If there is no signal or the amplitude is small, look for a defective sensor or a wiring problem.
- If the engine runs, connect the test tool as described in the test tool's Connection Help and start the engine. Run the test at idle and at different rpm's, and under various load conditions

Test Tool Key Sequence

- ①   

MENU
SENSORS
AIR/FUEL
IGNITION
ELECTRICAL SYSTEM
SCOPE
MULTIMETER
VEHICLE DATA
INSTRUMENT SETUP



 SELECT 

- ②  

SENSORS MENU
GENERAL SENSORS
OXYGEN SENSOR
DUAL OXYGEN SENSOR
TEMPERATURE SENSOR
KNOCK SENSOR
POTENTIOMETER

 SELECT 

- ③ Connect the test leads as displayed by the test tool's Connection Help and shown in Figure 5-44.

- ④   Starts the distributor triggering test.

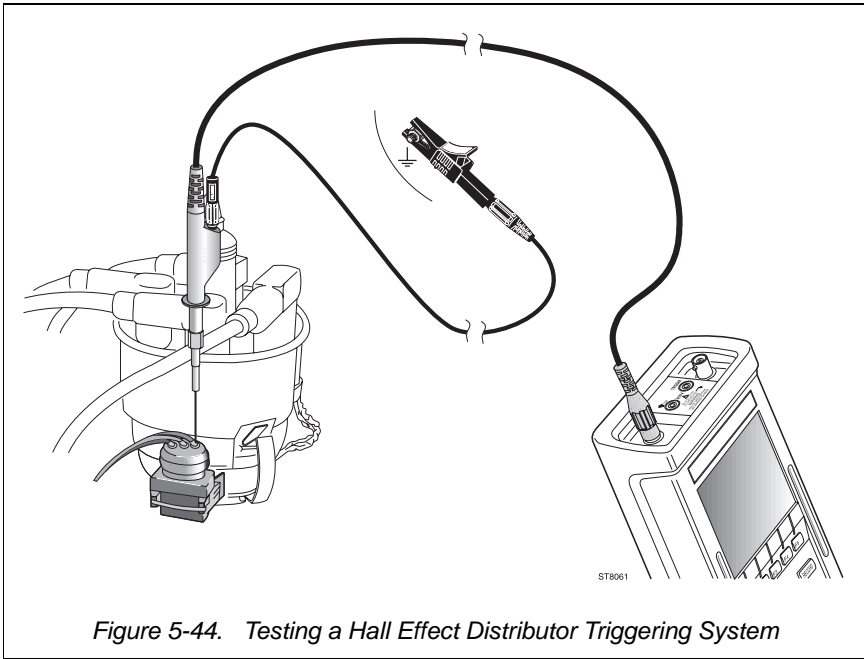

Figure 5-44. Testing a Hall Effect Distributor Triggering System

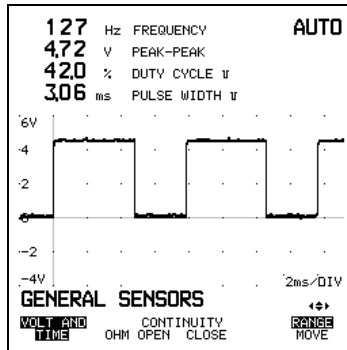
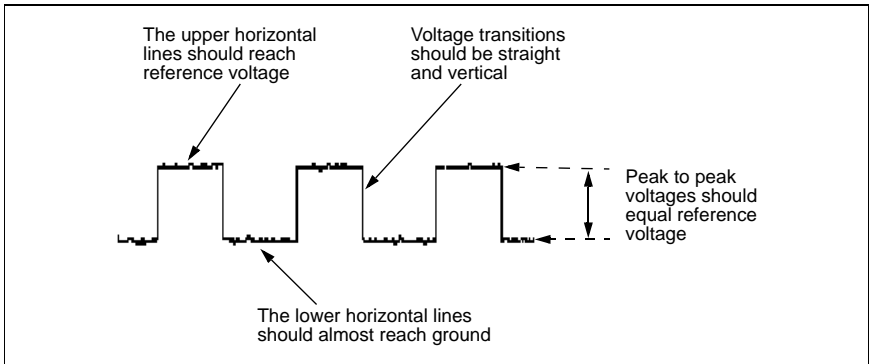

Figure 5-45. Result Display from a Hall Effect Distributor Triggering Test

Primary Distributor Triggering (Hall Effect)



The duty cycle of the signal remains fixed, determined by the spacing between shutter blades.

Frequency of the signal increases as the speed of the engine increases.

Specifications may vary. Consult manufacturer's specifications.

Primary Distributor Triggering (Magnetic)

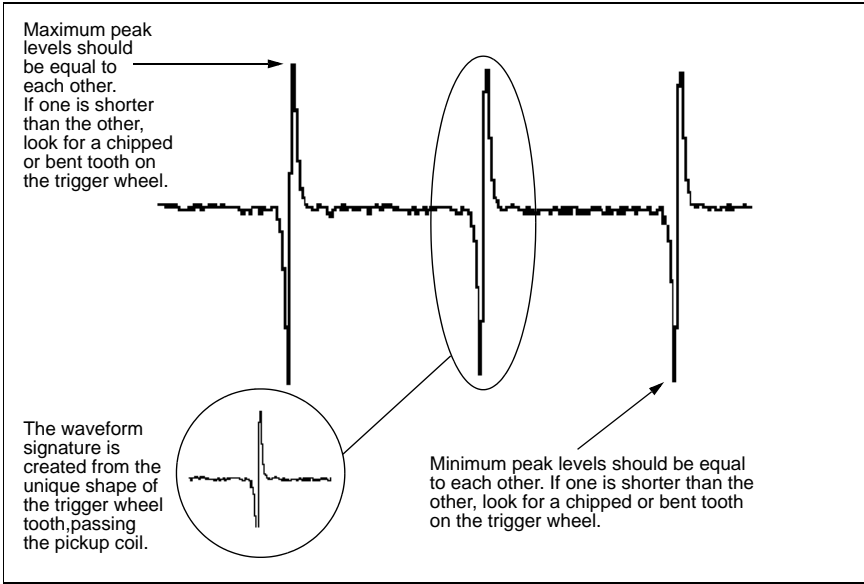

Primary Distributor Triggering (Optical)

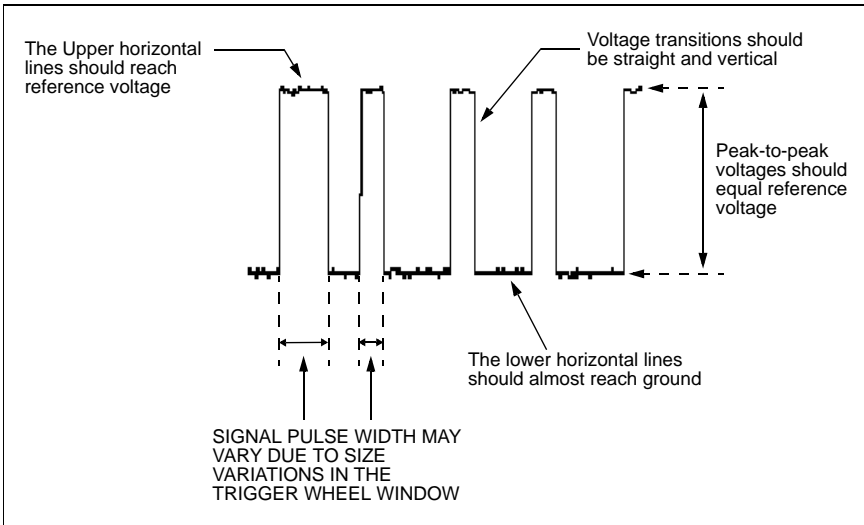

Specifications may vary. Consult manufacturer's specifications.



18 Relative Compression

The test tool calculates the relative compression of the cylinders by measuring the voltage drop or current increase created from each cylinder during cranking. For the synchronized (SYNC) relative compression test, the Trigger Pickup clamped on the spark plug wire of cylinder #1, is used to identify the cylinders in the result display. This is a very useful test to determine compression differences between cylinders and identify a weak cylinder. The Synchronized Relative Compression test does not work on DIS and COP systems, and on Diesel engines.



Measurement Conditions

- This test requires several conditions to get test results that can be interpreted properly and are not misleading. Verify test result by physical compression test prior to mechanical repair.
- Interpretation of test results is easier for engines with 6 cylinders or less. It becomes increasingly more difficult as the number of cylinders increase, due to more compression overlap and less difference in current draw of the starter motor.
- Disable engine run by momentarily interrupting the fuel supply. (Pull the fuel pump fuse or clamp the flexible fuel pressure line.)
- On some engines, holding the throttle wide open during cranking will give the best results to get an evenly distributed air intake.



Test Tool Key Sequence

- 1 
- 2 

MENU
SENSORS
AIR/FUEL
IGNITION
ELECTRICAL SYSTEM
SCOPE
MULTIMETER
VEHICLE DATA
INSTRUMENT SETUP

- 3 

SCOPE MENU
SINGLE INPUT SCOPE
DUAL INPUT SCOPE
REL. COMPRESSION UNSYNC
REL. COMPRESSION SYNC

- 4 Read the display for connection information and instructions to perform the test. See the test setup in Figure 5-46. Don't forget to connect the blue Filter Adapter on INPUT A. The Inductive Pickup must be clamped on the spark plug wire of the first cylinder **close to the spark plug**, otherwise the test may not work.
- 5  Starts the Synchronized Relative Compression test

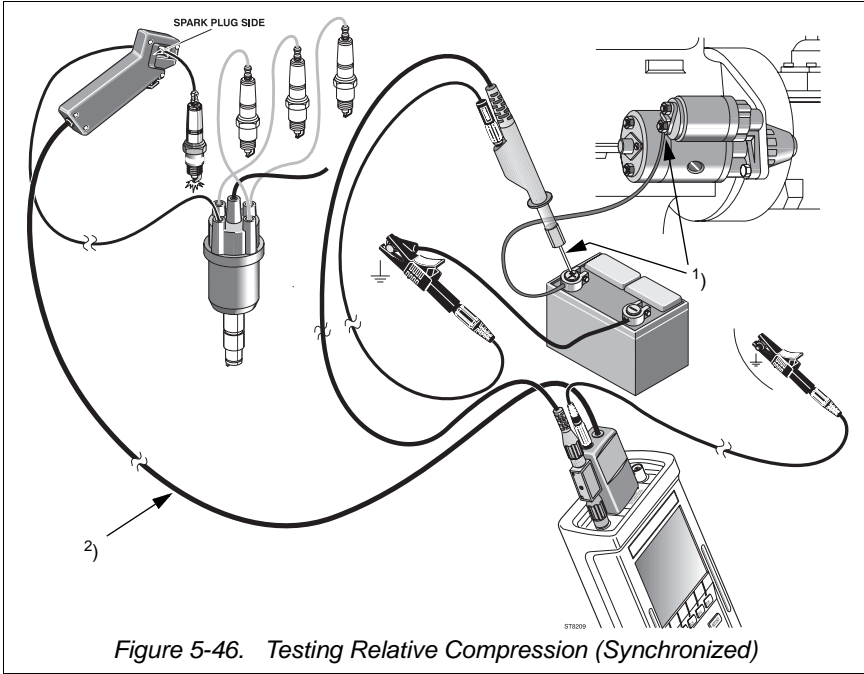

Figure 5-46. Testing Relative Compression (Synchronized)

- 1): If accessible, connection to the starter motor terminal is preferred.
- 2): The RPM90 Inductive Pickup is not used for the unsynchronized (UNSYN) Relative Compression test.

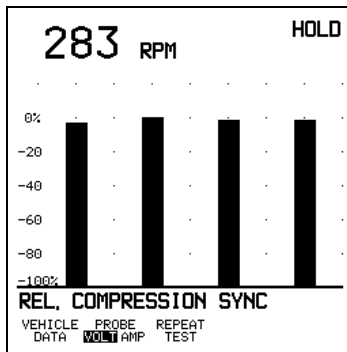

Figure 5-47. Result Display from a (Synced) Relative Compression Test

When using the synchronized Relative Compression test (REL. COMPRESSION SYNC), do not interrupt the ignition system to disable engine run, as the ignition system is needed to trigger the measurement via the RPM90 Inductive Pickup. Instead, disable fuel supply, e.g. remove the fuel pump fuse or disconnect fuel injector wires.

Tip: To speed your diagnosis, start your evaluation of the engine's mechanical condition by using the REL. COMPRESSION UNSYNC mode. This will quickly identify any low compression cylinders causing problems. To identify which cylinder is at fault, use the REL. COMPRESSION SYNC mode. Remember that the REL. COMPRESSION SYNC mode needs an electrical signal from cylinder number one's spark plug firing, so disable fuel not spark.

19 Timing Advance

Two channels of the ScopeMeter test tool are utilized to determine actual timing advance of the ignition system. INPUT A is connected to cylinder number one or the primary side of the ignition coil (module), and INPUT B is connected to the TDC signal.

Using the cursors, the calculated timing advance is shown in degrees of advance.





This test can also be used to test a knock sensor. See application #14.



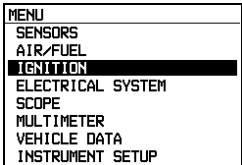

Measurement Conditions

- Connect the test tool to cylinder number one and to the Top Dead Center signal (TDC). Do not connect ground to the test lead on INPUT B (see Figure 5-48).
- Start the engine and allow the engine to idle. Slowly accelerate the engine while watching the display.
- As electronic and mechanical timing (where applicable) take over, an increase in ignition timing will be noted.

Test Tool Key Sequence

① 

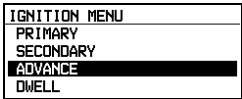
②    

③    

④ Connect the test leads as displayed by the test tool's Connection Help and shown in Figure 5-48. The Inductive Pickup must be clamped on the spark plug wire **close** to the spark plug.

⑤  Starts the timing advance test.

⑥ Move cursor 2 to the positions shown in Figure 5-49.

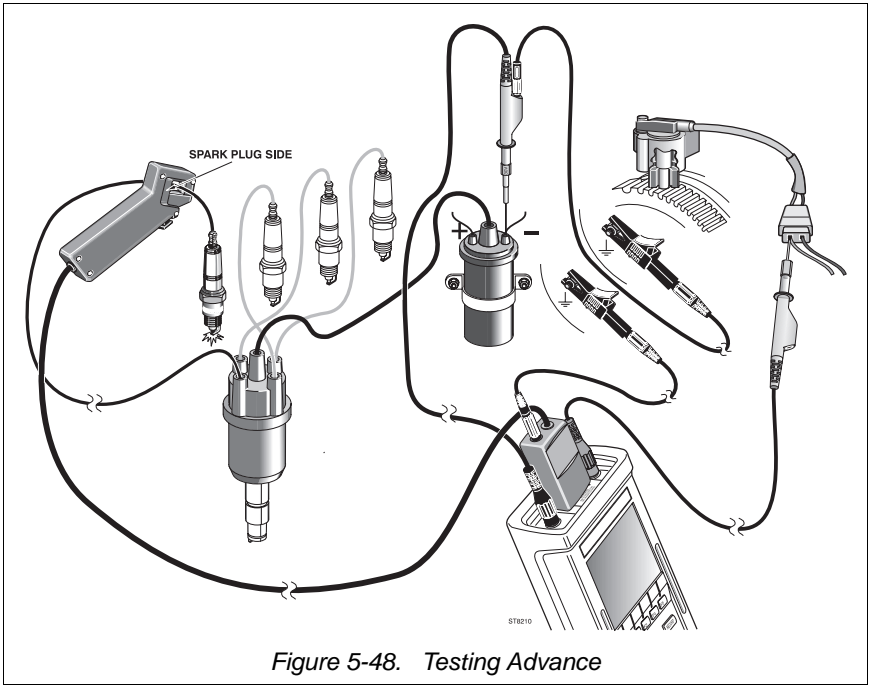

Figure 5-48. Testing Advance

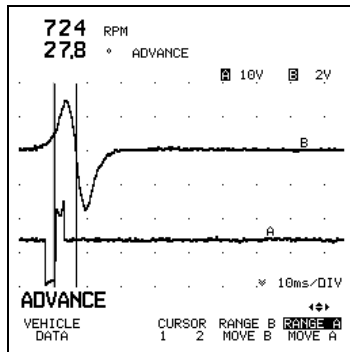
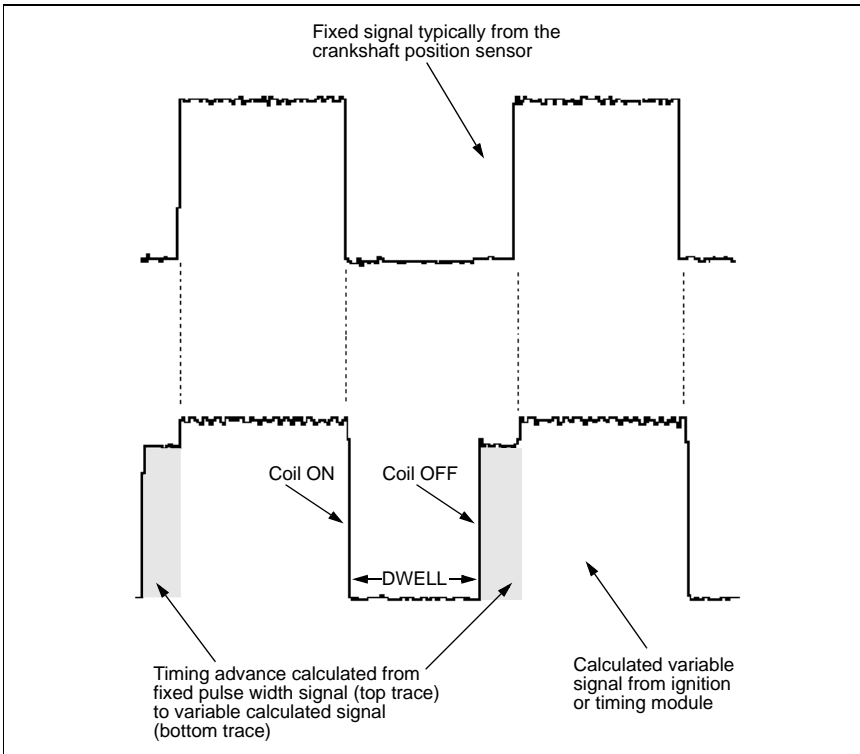

Figure 5-49. Result Display from an Advance Test

Timing Advance



Specifications may vary. Consult manufacturer's specifications.

ELECTRICAL SYSTEM

20 Battery Test

Charging system problems often come to you as a "no-start" complaint. The battery will have discharged and the starter will not crank the engine. The first step is to test the battery and charge it if necessary.



Measuring System Voltage

Bleed the surface charge from the battery by turning on the headlights for a minute. Now turn the lights off and measure the voltage across the battery terminals. When possible, individual cell specific gravity should be checked with a hydrometer. A load test should be done to indicate battery performance under load. Voltage tests only tell the state of charge, not the battery condition.



Measurement Conditions

- Connect the test tool to the vehicle's battery as described on the test tool's help screen.
- Crank the engine while watching the instrument's display.



Test Tool Key Sequence

- 
- 

MENU
SENSORS
AIR/FUEL
IGNITION
ELECTRICAL SYSTEM
SCOPE
MULTIMETER
VEHICLE DATA
INSTRUMENT SETUP

- 

ELECTRICAL SYSTEM MENU
CHARGING
BATTERY TEST
POTENTIOMETER
SOLENOID AND DIODE
VOLTAGE DROP
STEPPER MOTOR

- Read the display for connection information and instructions to perform the test. See the test setup in Figure 5-50.
- 

The battery test will now start.

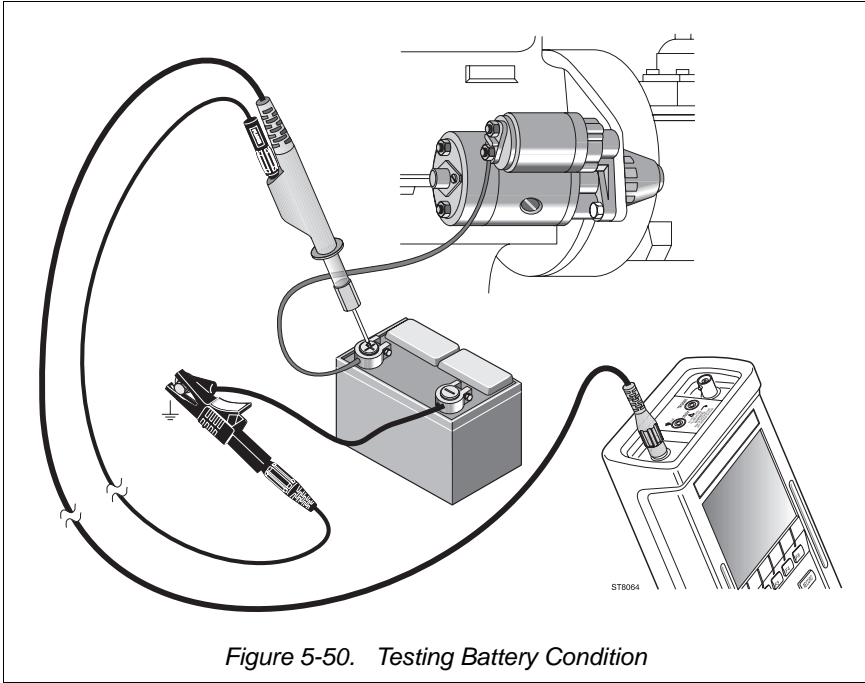

Figure 5-50. Testing Battery Condition

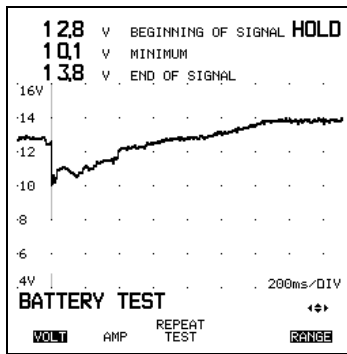

Figure 5-51. Result Display from a Battery Condition Test

21 Charging

Ripple Voltage, Output Voltage, Diode Test and Field Control

CHARGING OUTPUT TEST

Late model electronic voltage regulators maintain a charging voltage of about 13 to 15 volts. Sufficient output from the charging system is required to maintain battery charge and meet vehicle demands.

RIPPLE VOLTAGE MEASUREMENT

An alternator generates current and voltage by the principles of electromagnetic induction. Accessories connected to the vehicle's charging system require a steady supply of direct current at a relatively steady voltage level. You can't charge a battery with alternating current, so it must be rectified to direct current. A set of diodes, part of the alternator's rectifier bridge, modifies the ac voltage, produced in the alternator, to the dc voltage used by the car's systems. When analyzing a charging system, look for both ac and dc levels. The ac level is called ripple voltage and is a clear indication of diode condition. Too high a level of ac voltage can indicate a defective diode and discharge the battery.

RECTIFIER DIODE TEST

Three-phase alternators use three pairs of diodes to rectify output current. These diodes are typically found in an insulated heat sink or rectifier bridge. A diode must pass current in one direction and block it in the other. If a diode is shorted, it will pass current in both directions. If it is open, it will block current in both directions.

To test a diode for an open or a short circuit, touch one test lead of the instrument to the diode lead and the other lead to the heat sink or alternator frame. Then reverse the test leads. The instrument should show continuity in one direction but not in the other.

If continuity is indicated in both directions, the diode is shorted. If continuity is not indicated in either direction, the diode is open.

CHARGING FIELD CONTROL TEST

A voltage regulator controls alternator output by adjusting the amount of current flowing through the rotor field windings. To increase alternator output, the electronic voltage regulator allows more current to flow through the rotor windings.

If the battery is discharged, the regulator may cycle the field current on 90% of the time. This will increase output. If the electrical load is low, the regulator may cycle the field current off 90% of the time to decrease output.

Depending on the vehicle type, the signal may be a pulsewidth modulated square wave or a fixed voltage level.

Measurement Conditions

CHARGING OUTPUT TEST

- Connect the test tool to the vehicle's alternator.
- Engine RUNNING. Test the alternator at idle and under load. Slowly increase engine speed.
- Load the charging system by turning on vehicle accessories, such as the headlights, heater blower motor fan, and windshield wipers.

RIPPLE VOLTAGE MEASUREMENT

NOTE:

This measurement is made at the rear case half of the alternator and not the battery. The battery can act as a capacitor and absorb the ac voltage.

- Connect the test tool to the vehicle's alternator **BAT** terminal.
- Engine RUNNING. Test the alternator at idle and under load. Slowly increase engine speed.
- Load the charging system by turning on vehicle accessories, such as the headlights, heater blower motor fan, and windshield wipers.
- AC ripple voltage should not exceed 500 mV ac.

CHARGING FIELD CONTROL TEST

- Connect the test tool to the alternator's field connection.
- Engine RUNNING. Test the field control with the engine idling and under load.

RECTIFIER DIODE TEST

- Test the alternator's rectifier bridge diode set and trio with the alternator disassembled.
- Follow the vehicle manufacturers recommendations for diagnosing a defective alternator.

Test Tool Key Sequence

- ① 

- ② 

MENU
SENSORS
AIR/FUEL
IGNITION
ELECTRICAL SYSTEM
SCOPE
MULTIMETER
VEHICLE DATA
INSTRUMENT SETUP



- ③ 

ELECTRICAL SYSTEM MENU
CHARGING
BATTERY TEST
POTENTIOMETER
SOLENOID AND DIODE
VOLTAGE DROP
STEPPER MOTOR



- ④ Connect the test leads as displayed by the test tool's Connection Help and shown in Figure 5-52.

- ⑤  Starts the charging (dc) voltage test.

Use the F2 key to measure the charging ripple voltage.

Use the F3 key to measure the charging current with a Current Clamp.

Use the F4 key to measure the charging ripple current with a Current Clamp.

When using a Current Clamp, you must set it to zero before using it for measurements.

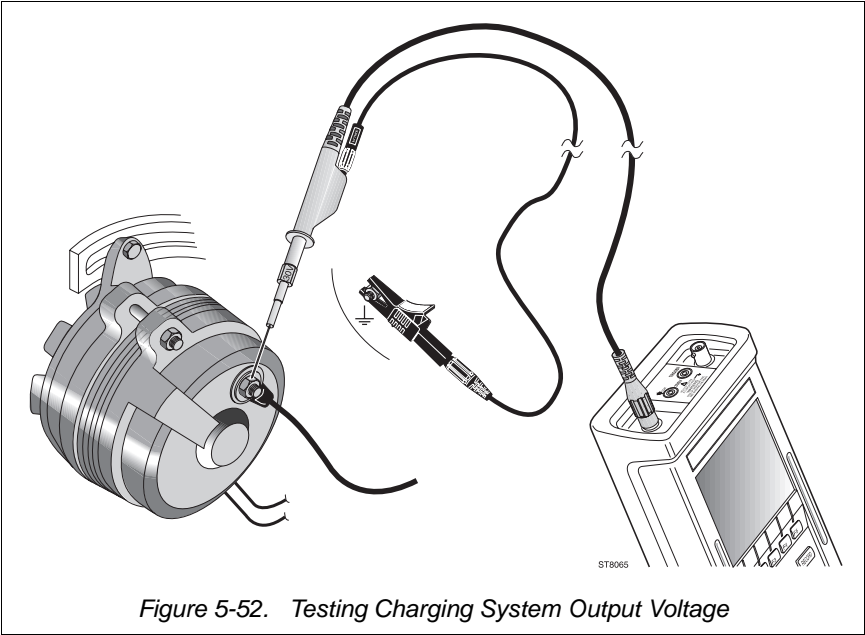

Figure 5-52. Testing Charging System Output Voltage

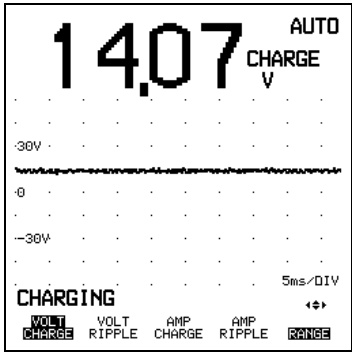

Figure 5-53. Result Display from Charging System Voltage Test

22 Solenoid and Clamping Diode Test







When an electromagnetically controlled device is de-energized, a voltage spike can be induced by the collapse of the magnetic field. Clamping (or suppression) diodes are used to filter out these inductive spikes. Horn circuits, relays, blower motors, air conditioning clutches, and some injectors are examples of devices that use diodes for this purpose.

A faulty diode can cause induced noise, often detectable over a car's audio system. These noise spikes are seen as large overshoots when the waveform transitions from one level to another. They can also cause interference in other more sensitive areas of the car's sensor and control system.

Measurement Conditions

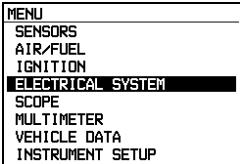
- Activate the item under test and watch the test tool's display .

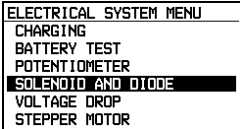
Test Tool Key Sequence

- ① 
- ②   
- ③   
- ④ Connect the test leads as displayed by the test tool's Connection Help and shown in Figure 5-54.
- ⑤  Starts the Solenoid and Clamping Diode test.

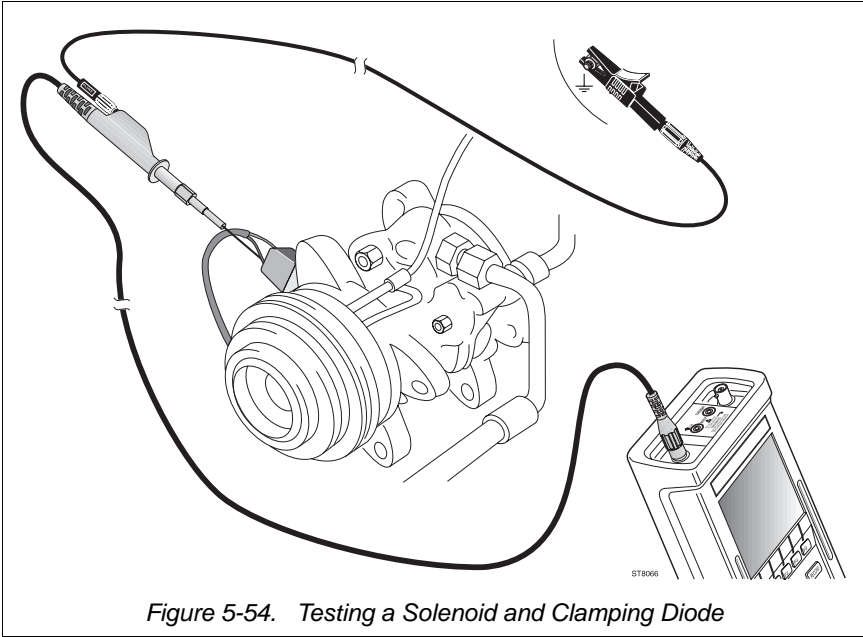

Figure 5-54. Testing a Solenoid and Clamping Diode

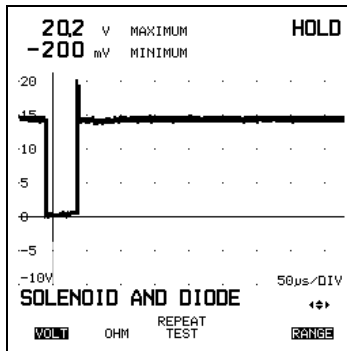
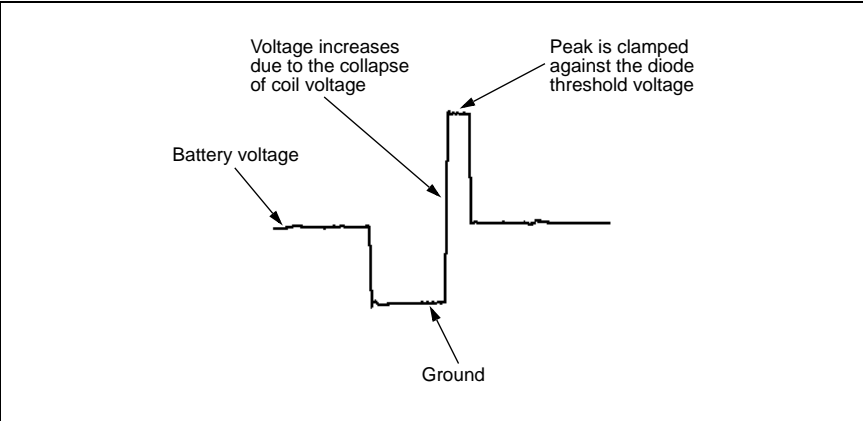

Figure 5-55. Result Display from a Solenoid and Clamping Diode Test

Clamping Diodes



Specifications may vary. Consult manufacturer's specifications.

23 Voltage Drop

In automotive circuits even the smallest loss of voltage will cause poor performance. Connect the instruments + lead to the side of the device nearer the battery positive terminal and the - lead to the side nearer the battery negative terminal or ground. Current must be flowing for the instrument to register the voltage drop found. The Voltage Drop test is helpful on components and connections (both on the + feed side and - ground side) except solenoids, which read battery voltage if you measure across them when the engine is being cranked.







Voltage drops should not exceed the following:

200 mV	Wire or cable
300 mV	Switch
100 mV	Ground
0 mV to <50 mV	Sensor Connections
0.0V	Connections

Measurement Conditions

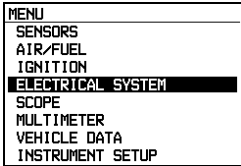
- Current must be flowing for the instrument to register the voltage drop found.
- The positive lead should be connected to the side of the device nearer the positive terminal of battery.

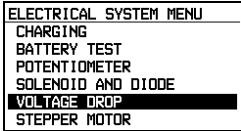
Test Tool Key Sequence

- ① 
- ②   SELECT 
- ③   SELECT 
- ④ Connect the test leads as displayed by the test tool's Connection Help and shown in Figure 5-56.
- ⑤  Starts the Voltage Drop test.

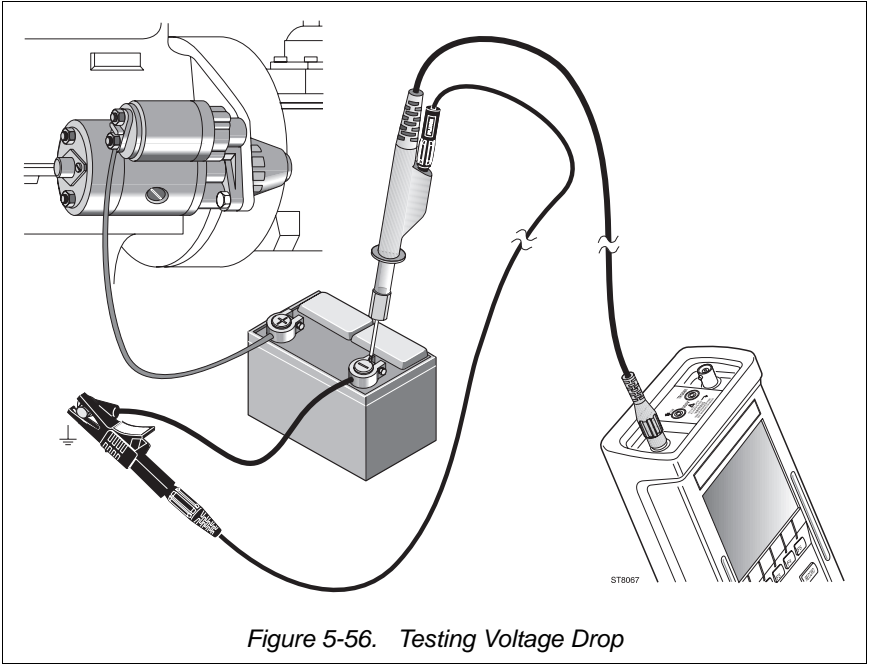

Figure 5-56. Testing Voltage Drop

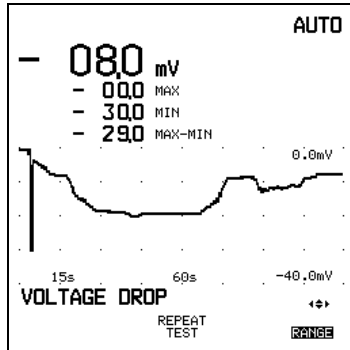

Figure 5-57. Result Display from a Voltage Drop Test

24 Voltage Tests

Voltage Reference and Ground

High resistance among grounds can be among the most frustrating of electrical problems. They can produce bizarre symptoms that don't seem to have anything to do with the cause, once you finally find it. The symptoms include lights that glow dimly, lights that come on when others should, gauges that change when the headlights are turned on, or lights that don't come on at all.





Voltage sources below the specified amounts can cause similar symptoms.



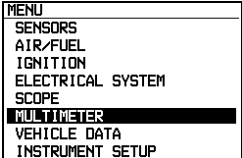

Measurement Conditions

- Refer to the vehicle manufacturer's wiring diagram for additional information on pin location and circuit descriptions.

Test Tool Key Sequence

① 

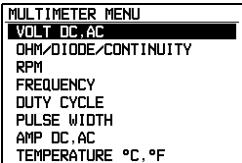
②    

③    

- ④ Connect the test leads as displayed by the test tool's Connection Help and shown in Figure 5-58.

⑤  Starts the Voltage test.

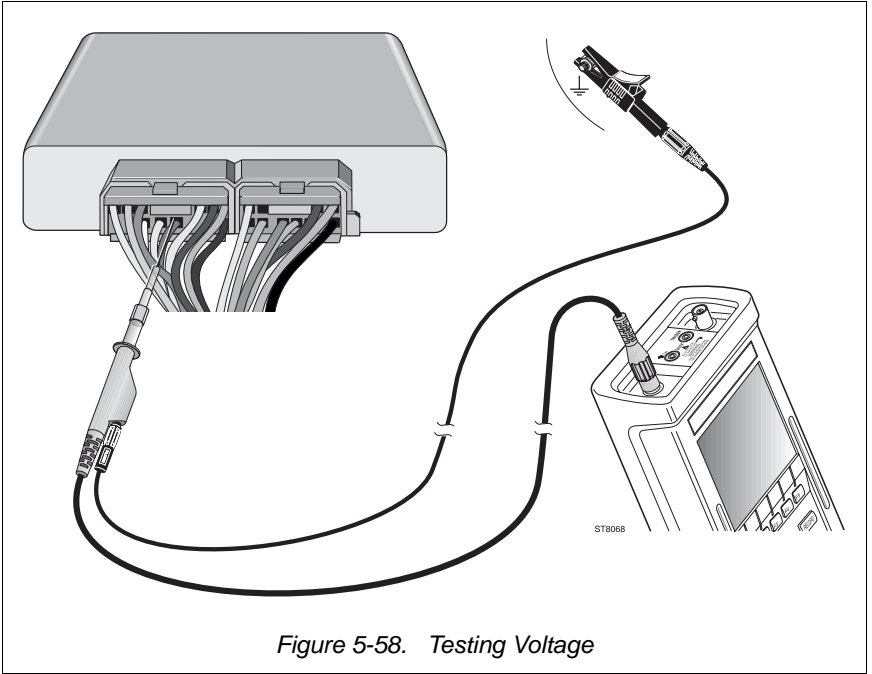

Figure 5-58. Testing Voltage

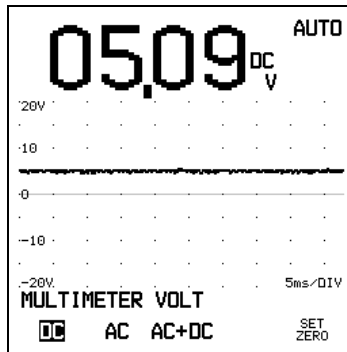

Figure 5-59. Result Display from a Voltage Test

DIESEL

Introduction

During the compression stroke of a diesel engine, the intake air is compressed to about 50 Bar (735 psi). The Temperature hereby increases to 700 to 900°C. This temperature is sufficient to cause automatic ignition of the Diesel fuel which is injected into the cylinder, shortly before the end of the compression stroke and very near to the TDC.

Fuel is delivered to the individual cylinders at a pressure of between 350 and 1200 Bar (5145 psi and 17,640 psi). The start of the injection cycle must be timed within 1° Crankshaft to achieve the optimum compromise between engine fuel consumption and combustion noise. A timing device controls the start of the injection and will also compensate for the propagation times in the fuel delivery lines.

Diesel rpm measurements are necessary for idle speed adjustments, maximum RPM checks and for smoke tests at fixed rpm values.

Measurement Conditions:

Cleaning

The fuel lines to measure on, should be cleaned in order to assure a good (metal) contact of the fuel line itself to the piezo pickup and ground clip. Use sandpaper and preferably a de-greaser to clean the lines.

Positioning and Probe connection

The Piezo adapter should be placed as close as possible to the Diesel injector on a straight part of the fuel line. Use the piezo-to-probe tip adapter and slide the faston to the pickup. clamp the ground clip close to the piezo pickup. Make sure that the groundclip does not make contact to the piezo itself or to adjacent fuel lines. Slide the probe tip onto the probe tip adapter and connect the Probe to your ScopeMeter. Notice that the groundwire is shorter than the signal wire, in order to have the weight of probe and cable on the groundwire and not on the signal wire.

The piezo element may not bounce or rattle on the line or make contact to other fuel lines or any other material close by.

Caution: The piezo adapter is made of a ceramic material and may be damaged if it falls on a concrete floor. Be careful.











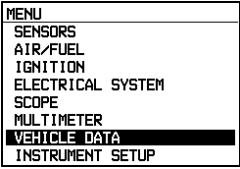

Some general suggestions to keep in mind:

- Always position the piezo pickup on the fuel line at about the same distance from the Injector.
- Place the pickup on a straight part of the fuel line. Do not place it on a bent part of the line.
- Always compare results with signals performed on a good engine to get acquainted with the signal shape.
- Always compare signals at the same engine speed.
- Pump timing is critical and should occur within 1degree of crankshaft rotation. The test tool is not a pump timing device. The test tool can be used to reveal ECU problems concerning timing and delivery start.

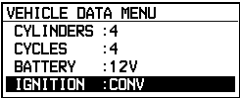







25 Diesel RPM Measurements and Diesel Injection Pattern Display

Test Tool Key Sequence

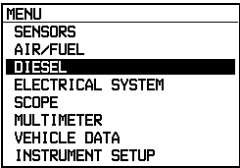
Set DIESEL in the VEHICLE DATA MENU as follows:

- ①  Displays the main MENU.
- ②    SELECT 
- ③    SELECT 
- ④    SELECT 
- ⑤ OK  Return to the main MENU.

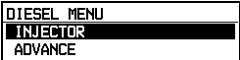
Proceed as follows to select the Diesel Injector test:

- ⑥    SELECT 
- ⑦    SELECT 
- ⑧ Connect the test leads as displayed by the test tool's Connection Help and shown in Figure 5-60.
- ⑨ OK  Starts the Diesel Injector test.

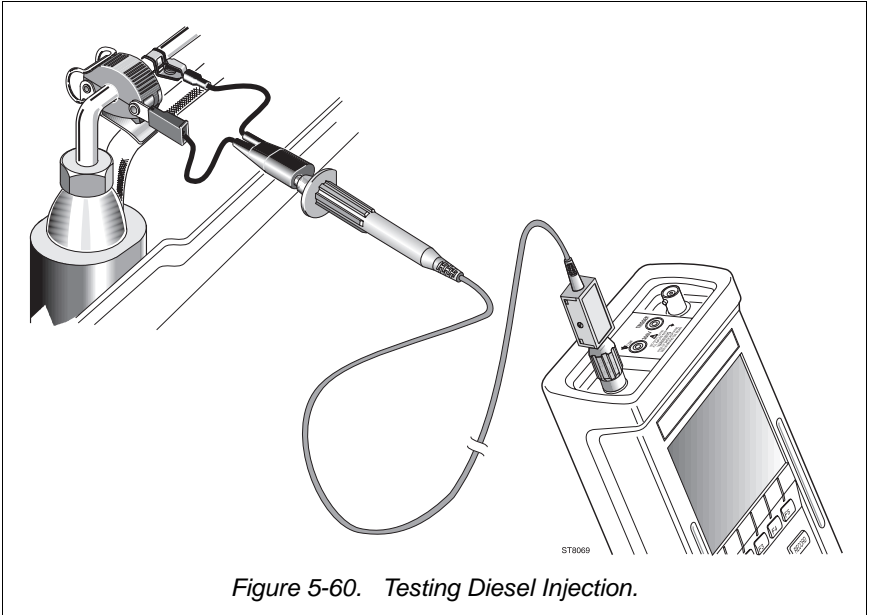

Figure 5-60. Testing Diesel Injection.

Analysis of Injection Pattern at Idle Speed

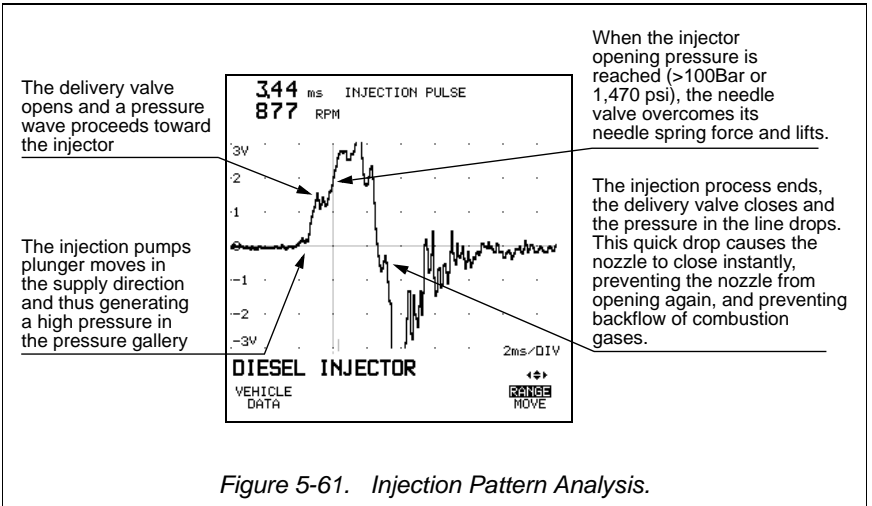

Figure 5-61. Injection Pattern Analysis.

26 Diesel Advance Measurement

Diesel pump testers are used to calibrate pumps exactly to the engine's requirements. They monitor pulses from the reference on the engine's flywheel. The start of the delivery is monitored and timing adjustments can be made at different speeds.

The advance measurement with the test tool is intended to reveal problems in the timing of the start of fuel delivery compared to the TDC signal of the flywheel sensor. This measurement is not meant to be an absolute and accurate diesel pump adjustment test.



The piezo pickup is clamped on the fuel line of the first cylinder, close to the injector and connected via the blue filter probe to INPUT A. (See Figure 5-62).

The TDC sensor signal is connected to INPUT B

Do not use the ground lead of Channel B, since the instrument is already grounded through the pickup adapter to the fuel line.



Test Tool Key Sequence

① 

②  

MENU
SENSORS
AIR/FUEL
DIESEL
ELECTRICAL SYSTEM
SCOPE
MULTIMETER
VEHICLE DATA
INSTRUMENT SETUP

SELECT 

③  

DIESEL MENU
INJECTOR
ADVANCE

SELECT 

④ Connect the test leads as displayed by the test tool's Connection Help and shown in Figure 5-62.

⑤  Starts the Diesel Advance test.

⑥ Position the cursors as shown in Figure 5-63.

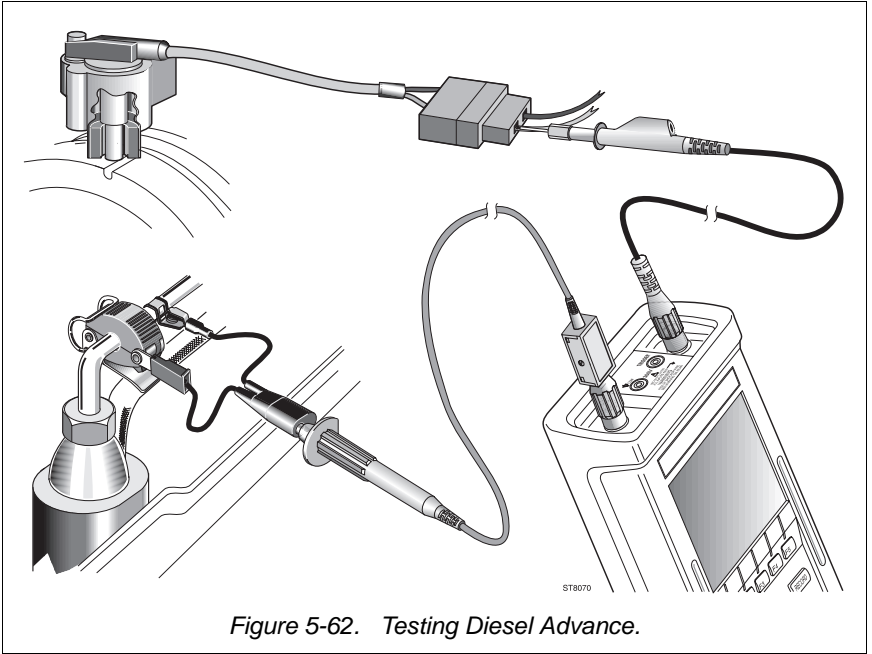

Figure 5-62. Testing Diesel Advance.

The following Figures show the results on the instrument screen.

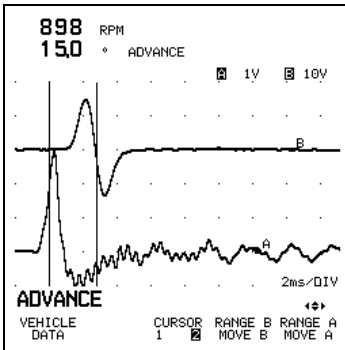

Figure 5-63. Advance at Idle.

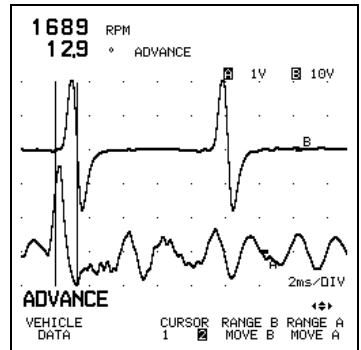

Figure 5-64. Advance at 1700 RPM.

Chapter 6

User Maintenance

CLEANING	6-2
KEEPING BATTERIES IN OPTIMAL CONDITION	6-2
REPLACING AND DISPOSING OF BATTERIES	6-4
FUSES NOT REQUIRED	6-5
CALIBRATING 10:1 TEST LEADS	6-6

**WARNING**

RISK OF ELECTRIC SHOCK OR FIRE:

USE ONLY INSULATED PROBES, TEST LEADS, AND CONNECTORS SPECIFIED IN THIS MANUAL WHEN MAKING MEASUREMENTS >42V PEAK (30V RMS) ABOVE EARTH GROUND OR ON CIRCUITS >4800 VA.

USE PROBES AND TEST LEADS WITHIN RATINGS AND INSPECT BEFORE USE. REMOVE UNUSED PROBES AND TEST LEADS. REMOVE PROBES AND TEST LEADS BEFORE OPENING CASE OR BATTERY COVER.

WHEN THE TEST TOOL IS CONNECTED TO ITS POWER ADAPTER/BATTERY CHARGER, TERMINALS MAY BE LIVE, AND THE OPENING OF COVERS OR REMOVAL OF PARTS (EXCEPT THOSE THAT CAN BE ACCESSED BY HAND) IS LIKELY TO EXPOSE LIVE PARTS.

THE TEST TOOL MUST BE DISCONNECTED FROM ALL VOLTAGE SOURCES BEFORE IT IS OPENED FOR ANY ADJUSTMENT, REPLACEMENT, MAINTENANCE, OR REPAIR.

CAPACITORS INSIDE MAY STILL BE CHARGED EVEN IF THE TEST TOOL HAS BEEN DISCONNECTED FROM ALL VOLTAGE SOURCES.

CLEANING

Clean the test tool with a damp cloth and a mild detergent. Do not use abrasives, solvents, or alcohol.

Do not use any type of paper to clean the display screen. This will cause scratches and diminish the transparency of the plastic screen. Use only a soft cloth with a mild detergent.

KEEPING BATTERIES IN OPTIMAL CONDITION







When new, the batteries typically provide 4 hours of use. To keep batteries in optimal condition, do the following:

Always operate the test tool on batteries until a blinking  appears in the top right of the display. This indicates that the battery level is too low and the batteries need to be recharged.

CAUTION

Frequent charging of the batteries when they are not completely empty can cause a "memory effect". This means that the capacity of the NiCad batteries decrease, causing a decrease in the operating time of the test tool.

You can revitalize a NiCad battery pack with too low capacity as follows:

- ① Ensure that the test tool is battery operated (Power Adapter disconnected).
- ②  Press the power-on key to turn the test tool on.
- ③   Press this key twice to enter the main MENU.
- ④  Press to select SENSORS.
- ⑤  Press to select GENERAL SENSORS.
If Connection Help information is displayed, press F1.
- ⑥  Press to display the RECORD menu.
- ⑦  Press to select PLOT READINGS.
If a message is displayed telling that memory data will be lost, press F1 (YES) to start recording.

The recording function disables the battery save feature when no key entry is made for 5 minutes. Wait until the test tool is automatically turned off. Then the NiCad batteries are completely discharged. Depending on the condition of the NiCad batteries, the discharging can last up to 8 hours.

- ⑧ When the test tool is turned off, connect the Power Adapter/Battery Charger PM8907 to the test tool and the local line power.
- ⑨ Charge for more than 21 hours.
- ⑩ Repeat steps 1 through 9 once more.

REPLACING AND DISPOSING OF BATTERIES



WARNING

TO AVOID ELECTRICAL SHOCK, REMOVE THE TEST LEADS, PROBES, AND BATTERY CHARGER BEFORE REPLACING THE BATTERIES.

- ① Disconnect the test leads, probes, and battery charger both at the source and at the test tool.
- ② Separate the test tool from its holster.
- ③ Locate the battery cover on the bottom rear. Loosen the two screws with a flat-blade screwdriver.
- ④ Lift the battery cover away from the test tool.
- ⑤ Remove the NiCad battery pack (or alkaline batteries, type KR27/50 or R14) from the battery compartment.



NOTE

Ni-Cd

This instrument contains a Nickel-Cadmium battery. Do not dispose of this battery with other solid waste. Used batteries should be disposed of by a qualified recycler or hazardous materials handler. Contact your authorized Fluke Service Center for recycling information.

- ⑥ Install a new NiCad battery pack (PM9086) or new alkaline (C Cell) batteries (type KR27/50 or R14) as shown in Figure 6.1.

NOTE

Ensure that the NiCad battery pack charging contact is aligned in the battery compartment as shown in Figure 6.1. Use only the PM9086 NiCad battery pack.

- ⑦ Reinstall the battery cover and secure the two screws.

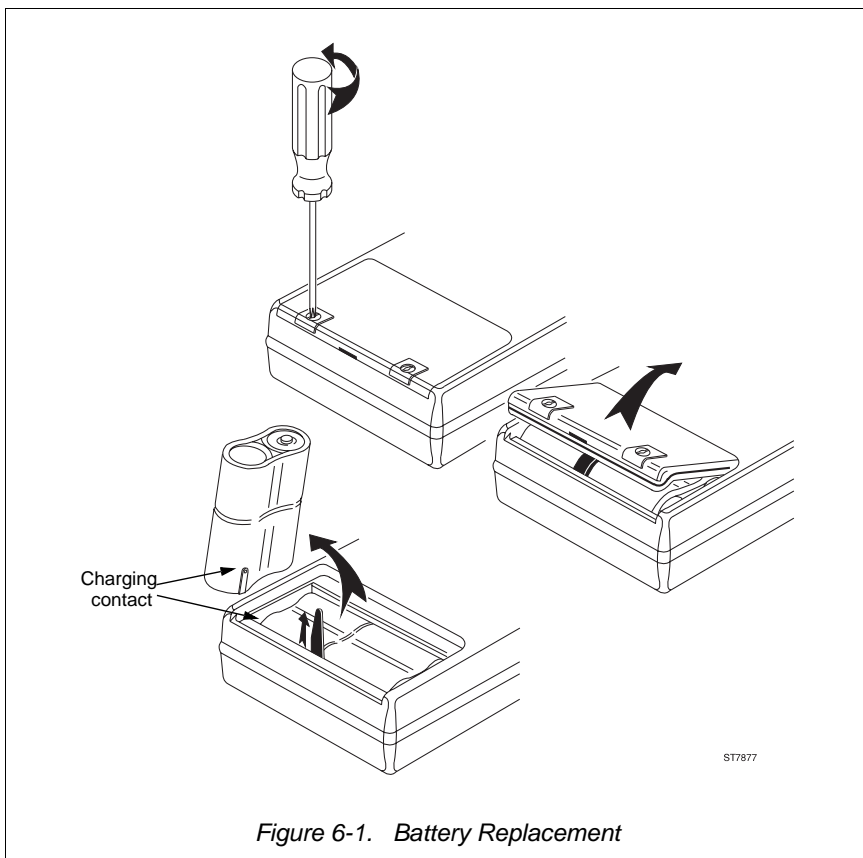

FUSES NOT REQUIRED

Since the test tool uses electronically protected inputs, no fuses are required.













CALIBRATING 10:1 TEST LEADS

The following procedure describes dc calibration for 10:1 test leads. Other test leads need no calibration.

NOTE:

To meet full user specifications, use a 10:1 test lead only with the input on which it has been calibrated.

10:1 Test Lead Calibration Procedure

- ① Make sure that the test lead to be calibrated is a 10:1 test lead. Select 10: 1 TEST LEAD setting in the INSTRUMENT SETUP MENU for INPUT A and/or INPUT B, depending on which input the test lead is to be calibrated. Refer to 'Changing Test Lead Setup' in Chapter 3. Set the test tool in SCOPE → DUAL INPUT SCOPE. This enables calibration on both inputs. Perform the following procedure with the DUAL INPUT SCOPE function active.
- ②  Press to display the menu.
- ③ 
 Use the arrow keys to highlight INSTRUMENT SETUP
- ④ 
 Press to select the INSTRUMENT SETUP MENU
- ⑤ 
 Use the arrow keys to highlight TEST LEAD INPUT A or TEST LEAD INPUT B.
- ⑥ 
 Press this key to select TEST LEAD SETUP for INPUT A or INPUT B. Check that TEST LEAD (displayed in the present menu) is set to 10:1. Otherwise set it to 10:1.
- ⑦ 
 Use the arrow keys to highlight CALIBRATE TEST LEAD
- ⑧ 
 Press to select the CALIBRATE TEST LEAD procedure.

- ⑨ Make the connections as displayed by the test tool.
(See Figure 6-2.)
- ⑩ Read the instructions displayed, to complete the calibration procedure.

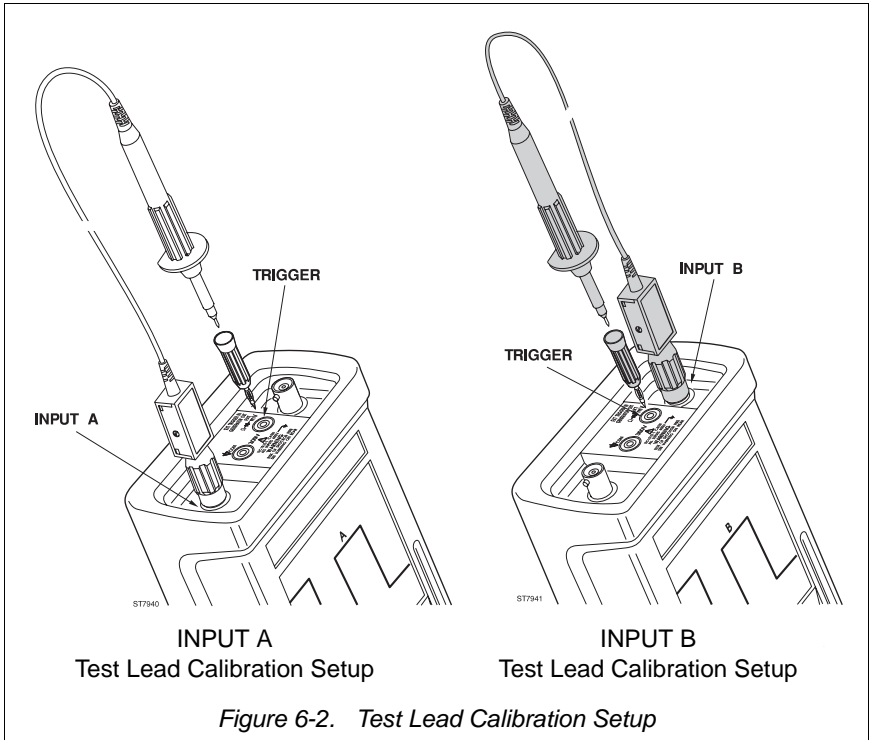

Chapter 7 Appendixes

APPENDIX 7A	Specifications	7-1
APPENDIX 7B	Parts and Accessories	7-14
APPENDIX 7C	PM8907 Information	7-17
APPENDIX 7D	Warranty and Service Centers	7-19
APPENDIX 7E	Terminology	7-25

APPENDIX 7A Specifications

INTRODUCTION

Performance Characteristics

FLUKE guarantees the properties expressed in numerical values with the stated tolerance. Specified non-tolerance numerical values indicate those that could be nominally expected from the mean of a range of identical ScopeMeter test tools.

Automated tests including Engine, Diesel, Sensor, Electrical System, and Meter tests are specified for input A. Scope specifications apply to both inputs A and B. Banana jacks are used for external trigger input only. For definitions of terms, refer to IEC Publication 351-1.

Safety Characteristics

The ScopeMeter test tool has been designed and tested in accordance with IEC Publication 1010, Safety Requirements for Electronic Measuring Apparatus. This manual contains information and warnings that must be followed by the user to ensure safe operation and to keep the instrument in a safe condition. Use of this equipment in a manner not specified by the manufacturer may impair protection provided by the equipment.

Environmental Data

The environmental data mentioned in this manual are based on the results of the manufacturer's verification procedures.

Engine Tests

RPM	600 - 15,000 RPM, 1 RPM resolution <1000 RPM, 10 RPM resolution >1000 RPM
Dwell Range	Degree: 0 to 360°, 1° resolution Milliseconds: 0 to 1,000 ms (1 ms resolution) Percentage: 0% - 100%, resolution 3 digits
Timing Advance (TDC)	in degrees (°) crankshaft rotation
Ignition Patterns	(● indicates the test tool can measure it.)

IGNITION TYPE	PRIMARY		SECONDARY	
	SINGLE	PARADE	SINGLE	PARADE
Conventional	●	●	●	●
DIS	●		●	
Coil on Plug	●			

Primary Voltage	0 to 300V
Secondary Voltage	0 to 80 kV
Burn Time	0.6 ms to 5 ms
Burn Voltage	0 to 80 kV
Relative Compression	0 to -100% contribution
Alternator Ripple Voltage	0 to 300V
Battery Condition Test	0 to 40V
Fuel Injection Pulse Width	0 to 1800 ms
Systems Automatically Tested:	Saturated Driver
	Conventional
	Throttle Body Injection Systems
	Current Controlled
	Peak And Hold
	Pulse Modulated

Diesel Tests (with Optional DPS90 Diesel Probe Set)

Engine Speed	400 to 10,000 RPM
Advance (Diesel Pump Timing)	in ° of crankshaft rotation
Injection Pulse	10 μ s to 1200 ms

Automated Sensor Tests

The Sensors menu gives direct access to a wide variety of sensor measurements. The best operating mode is automatically selected. A few of the sensors tested automatically include:

- Mass Air Flow Sensor (MAF)
- Manifold Absolute Pressure (MAP)
- Oxygen Sensor (Zirconium and Titanium)
- Dual Oxygen Sensor
- Temperature Sensors
- Position Sensors
- Camshaft Position
- Exhaust Gas Recirculation (EGR)
- Ride Height Sensors
- Magnetic Sensors
- Speed Sensors
- Knock Sensors
- Distributor Triggering

Horizontal

Modes Recurrent, Single Shot, Roll

RANGES:

Recurrent 20 μ s to 1 s/div
 Dual input alternating 1 μ s to 20 μ s/div
 Dual input chopped 50 μ s to 1 s/div

Single Shot..... 1 μ s to 200 ms/div

Roll..... 500 ms to 60 s/div

Dual input chopped 20 μ s to 60 s/div

Accuracy $\pm(0.1\% + 1 \text{ pixel})$

Record Length..... 512 samples (20 divisions)

Trigger

Sources A, B or TRIGGER (external)

Sensitivity: A or B <0.5 div to 1 MHz
 <1.5 div to 5.5 MHz

Sensitivity: TRIGGER..... +0.2V and 2.0V (TTL level compatible)

External Input Impedance 1.5 M Ω //40 pF direct

Delay Time -1 div

Cursor Measurements

Single input (INPUT A) cursor measurements:

- Voltage at CURSOR 1.
- Voltage at CURSOR 2.
- Voltage difference (ΔV) between the CURSOR 1 and CURSOR 2 positions.
- Time difference (Δt) between the CURSOR 1 and CURSOR 2 positions.

Dual input cursor measurements:

- Voltage at CURSOR 1 on the INPUT A signal waveform.
- Voltage at CURSOR 1 on the INPUT B signal waveform.
- Voltage at CURSOR 2 on the INPUT B signal waveform.
- Voltage at CURSOR 2 on the INPUT A signal waveform.
- Time difference (Δt) between the CURSOR 1 and CURSOR 2 positions.

Meter Mode

Displays numeric reading and waveform of the signal on INPUT A.

Measurement readout: Absolute, relative (set zero function).

DC Voltage

Ranges

direct input with STL90 leads 100 mV, 300 mV, 1V, 3V, 10V, 30V, 100V, 300V
 Accuracy..... $\pm(0.5\% + 5 \text{ counts})$
 Full Scale Reading 1000 or 3000 counts
 Normal Mode Rejection..... $>50 \text{ dB}$ at 50 or 60 Hz
 Common Mode Rejection..... $>100 \text{ dB}$ at DC, 50, 60, or 400 Hz

AC or AC+DC True RMS Voltage

Ranges

direct input..... 100 mV, 300 mV, 1V, 3V, 10V, 30V, 100V, 250V
 Accuracy (valid from 5% range) 50 Hz to 60 Hz $\pm(1\% + 10 \text{ counts})$
 20 Hz to 20 kHz $\pm(2\% + 15 \text{ counts})$
 5 Hz to 1 MHz $\pm(3\% + 20 \text{ counts})$
 Full Scale Reading 1000 or 3000 counts
 Crest Factor Automatic ranging on crest factor overload
 Common Mode Rejection Ratio $>60 \text{ dB}$, DC to 60 Hz

Frequency 1 Hz to 5 MHz

Resolution 4 digits

Accuracy..... $\pm(0.5\% + 2 \text{ counts})$

RPM selectable: n pulses/720°.

Range..... 600 RPM to 5,000 RPM

Resolution 4 digits

Accuracy..... $\pm(1\% + 5 \text{ counts})$

Duty Cycle positive or negative pulse

Range..... 2.0% to 98.0%

Accuracy (logic or pulse waveforms)..... $\pm(0.5\% + 2 \text{ counts})$

Pulse Width positive or negative pulse.

Range..... 250 μs to 50 ms

Resolution 3 digits

Accuracy..... $\pm(0.5\% + 2 \text{ counts})$

°C / °F Temperature for optional temperature probes

TR90: Range..... $-50 \text{ }^\circ\text{C}$ to $+200 \text{ }^\circ\text{C}$ (-58 to $+392 \text{ }^\circ\text{F}$)

Accuracy $\pm(1\% + 0.5 \text{ }^\circ\text{C})$

Other: Scaling..... 1 mV/degree

Amperes for optional current probes

Scaling 1 mV/A, 10 mV/A, 100 mV/A, 1 V/A (1 mV/mA)

Coupling DC, AC rms, or AC+DC rms

Range..... 2000A maximum

Resistance

Ranges.....	30Ω, 300Ω, 3 kΩ, 30 kΩ, 300 kΩ, 3 MΩ, 30 MΩ
Accuracy (300Ω to 30 MΩ)	±(0.5% +5 counts)
Accuracy (30Ω)	±(2.5% +25 counts)
Full Scale Reading.....	3000 counts
Measurement Current	500 μA, 500 μA, 70 μA, 7 μA, 700 nA, 70 nA, 70 nA
Open Circuit Voltage	<4V
Full Scale Voltage	<250 mV to 3 MΩ, <2V to 30 MΩ

Diode Test

Open Circuit Voltage	≤4V
Full Scale voltage.....	2.800V
Measuring Current	0.5 mA

Measurement Modifying Functions

- SMOOTH Moving average of readings up to last 8 seconds.
- Fast Update.....Fast display update for IGNITION single cylinder test.
- FREEZE (HOLD)..... Holding of last stable reading on display
- SET ZEROZeros present reading as a reference value

Record Capabilities

Plot Readings

Plots up to 4 readings over time simultaneously.

Min Max Trendplot™

Logs minimum, maximum, and average readings to memory at full accuracy and displays all three as graphs. Uses automatic vertical scaling and horizontal time compression for hands-off recording from a minimum of 60 seconds to a maximum 32 days full screen. The horizontal time compression process records data until the screen is full. Then it selects the greater maximum and the lesser minimum between each pair of readings. These readings are then compressed to fill half the screen. The process then repeats itself until up to 32 days have passed.

Intermittent Record

Monitors and records signal continuously for a full 128 screens (single channel) or 64 screens (dual channel) of data. Intermittent recording is initiated on entry and is terminated at any time by pressing any key on the instrument (except ON/OFF). Time base ranges 20 ms per division and slower (> 20 ms/division).

Flight Record

Records up to 40 successive screen snapshots in memory. Preserves the last 40 screens in an endless loop fashion. Time base ranges 200 ms per division and faster (< 200 ms/division).

Screen Memories (Save or Recall)

Memory 15 complete display screens including setup

Test Lead Calibration DC adjustment for 10:1 test leads only

General Specifications

Functional on These Engine Types:

Number of Cylinders 1, 2, 3, 4, 5, 6, 8
 Engine Stroke..... 2 or 4 stroke
 Fuel Types..... Gasoline, Diesel
 Ignition Systems..... Conventional, DIS, Coil-on-Plug
 Electrical System Voltages..... 6, 12, 24V
 (Use gasoline settings for alternative fuel tests)

The accuracy of all measurements are within +(% of reading + number of counts) from 18 °C to 28 °C. Add 0.1 x (specific accuracy) for each °C <18 °C or >28 °C.

Display

Type Foil Compensated Super Twisted Liquid Crystal
 Size 84 x 84 mm (4.7" diagonal)
 Resolution 240 x 240 pixels
 Contrast..... User adjustable
 Backlight..... Cold Cathode Fluorescent (CCFL) Tube
 High Brightness..... 50 cd/m²



External Power Requirements

Internal Battery Pack..... NiCad 4.8V nominal
 Operating Time Typically 4 hours
 Power Adapter/Battery Charger
 Charging Time Typically 16 hours
 Alternate battery 4 Alkaline C cells (non-rechargeable)
 External Supply 8 to 20V DC, 5 W typical via 5 mm jack



WARNING

THE MINUS VOLTAGE IS CONNECTED TO COMMON. WHEN USING A POWER SUPPLY THAT IS NOT DOUBLE INSULATED, CONNECT COMMON TO PROTECTIVE GROUNDING.

Memory back-up battery CR2032
 save screens for up three years with main batteries removed

Environmental

Temperature

Operating..... 0 °C to 50 °C
 Storage..... -20 °C to 70 °C

Humidity

Operating.....20 °C to 30 °C, 90% RH noncondensing
 30 °C to 50 °C, 70% RH noncondensing
 Storage..... 95% RH

Altitude

Operating..... 3 km (10,000ft)
 Storage..... 12 km (40,000ft)

Shock and Vibrationper MIL-T-28800 for Class 3

Electro-Magnetic Interference..... meets the following specifications
 (see also “DECLARATION OF CONFORMITY” on page X)

The Fluke 98 series II, including standard accessories, conforms with the EEC Directive 89/336 for EMI immunity, as defined by IEC 801-3, with the addition of the following tables (1 to 12).

Scope Mode:

Table 1:

	Susceptibility: no visible disturbance		
Frequency range: 10 kHz - 25 MHz	E = < 0.1 V/m	E = 1 V/m	E = 3 V/m
Stand alone / with STL90	5 mV/div - 100 V/div	5 mV/div - 100 V/div	5 mV/div - 100 V/div

Table 2:

	Susceptibility: no visible disturbance		
Frequency range: 25 MHz ... 1 GHz	E = < 0.1 V/m	E = 1 V/m	E = 3 V/m
Stand alone	5 mV/div - 100 V/div	5 mV/div - 100 V/div	5 mV/div - 100 V/div
With STL90	5 mV/div - 100 V/div	200 mV/div - 100 V/div	500 mV/div-100 V/div

Table 3:

	Susceptibility: disturbance less than 10% of full scale		
Frequency range: 25 MHz ... 1 GHz	E = < 0.1 V/m	E = 1 V/m	E = 3 V/m
Stand alone	N/A	N/A	N/A
With STL90	N/A	50 mV/div - 100mV/div	100 mV/div - 200 mV/div

For conditions not specified in tables 1,2, and 3, a susceptibility effect of more than 10% is possible.

N/A = Not Applicable

Multimeter Mode:

Table 4:

	Susceptibility: no visible disturbance		
Frequency range: 10 kHz ... 25 MHz	E = < 0.1 V/m	E = 1 V/m	E = 3 V/m
Stand alone / with STL90	100 mV - 300V	100 mV - 300V	300 mV - 300V

Table 5:

	Susceptibility: no visible disturbance		
Frequency range: 25 MHz ... 1 GHz	E = < 0.1 V/m	E = 1 V/m	E = 3 V/m
Stand alone	100 mV - 300V	100 mV - 300V	100 mV - 300V
With STL90	100 mV - 300V	100 mV - 300V	300 mV - 300V

Table 6:

	Susceptibility: disturbance less than 10% of full scale		
Frequency range: 25 MHz ... 1 GHz	E = < 0.1 V/m	E = 1 V/m	E = 3 V/m
Stand alone	N/A	N/A	N/A
With STL90	N/A	N/A	100 mV

N/A = Not Applicable

Automated Oxygen Sensor Test:

Table 7:

	Susceptibility: no visible disturbance		
Frequency range: 10 kHz ... 25 MHz	E = < 0.1 V/m	E = 1 V/m	E = 3 V/m
Stand alone / with STL90 + filter adapter	50 mV/div - 10 V/div	50 mV/div - 10 V/div	50 mV/div - 10 V/div

Table 8:

	Susceptibility: no visible disturbance		
Frequency range: 25 MHz ... 1 GHz	E = < 0.1 V/m	E = 1 V/m	E = 3 V/m
Stand alone	50 mV/div - 10 V/div	50 mV/div - 10 V/div	50 mV/div - 10 V/div
With STL90 + filter adapter	50 mV/div - 10 V/div	100 mV/div - 10 V/div	200 mV/div - 10 V/div

Table 9:

	Susceptibility: disturbance less than 10% of full scale		
Frequency range: 25 MHz ... 1 GHz	E = < 0.1 V/m	E = 1 V/m	E = 3 V/m
Stand alone	N/A	N/A	N/A
With STL90	N/A	50 mV/div	100 mV/div

For conditions not specified in tables 7,8 , and 9, a susceptibility effect of more than 10% is possible.

N/A = Not Applicable

Engine Test, ignition pattern: Secondary DIS:

Table 10:

	Susceptibility: no visible disturbance		
Frequency range: 10 kHz ... 25 MHz	E = < 0.1 V/m	E = 1 V/m	E = 3 V/m
Stand alone / with PM9096/101	500 V/div - 20 kV/div	500 V/div - 20 kV/div	500 V/div - 20 kV/div

Table 11:

	Susceptibility: no visible disturbance		
Frequency range: 25 MHz ... 1 GHz	E = < 0.1 V/m	E = 1 V/m	E = 3 V/m
Stand alone	500 V/div - 20 kV/div	500 V/div - 20 kV/div	500 V/div - 20 kV/div
With PM9096/101	500 V/div - 20 kV/div	500 V/div - 20 kV/div	1 kV/div - 20 kV/div

Table 12:

	Susceptibility: disturbance less than 10% of full scale		
Frequency range: 25 MHz ... 1 GHz	E = < 0.1 V/m	E = 1 V/m	E = 3 V/m
Stand alone	N/A	N/A	N/A
With STL90	N/A	N/A	500 V/div

N/A = Not Applicable

Mechanical

Size exclusive holster.....60 x 130m x 260 mm (2.4 x 5.1 x 10.2 inches)
 Size inclusive holster.....65 x 140 x 275 mm (2.5 x 5.5 x 10.8 inches)
 Weight exclusive holster 1.5 kg (3.3 lbs)
 Weight inclusive holster 1.8 kg (4.0 lbs)

Safety



Designed to Category III per IEC 1010 approved for 600V measurements on industrial power distribution systems.

Overload protection on INPUT A or INPUT B 300 Vrms
 Overload protection on EXTERNAL input 300 Vrms
 Surge Protection 4 kV
 per IEC 664 and ANSI/IEEE C62.41 test method
 Maximum Isolation to Earth..... 600 Vrms from any terminal
 Optical Interface Optically Isolated to 600 Vrms

NOTE

The input impedance of INPUT A or INPUT B drops significantly when the voltage on the input exceeds 400 Vrms.

Accessory Information

Standard Accessories (included with your Automotive ScopeMeter Test Tool)

Shielded Test Leads (STL90)

Bandwidth	0 to 200 Mhz
Test lead capacitance	240 pF
Voltage to ground	600V
Maximum input voltage	300V
Maximum current	3A
Maximum cable resistance.....	100 mΩ
Temperature	0 - 50 °C (operating) -40 - 70 °C (non-operating)

Inductive Trigger Pickup (RPM90)

Maximum RPM.....	16,000 RPM @ 4 stroke / 4 cylinder 8,000 RPM @ 2 stroke / 1 cylinder
Accuracy	5% of reading
Current range (of measured conductor).....	0 to 10 amperes
Cable length	3 meters (10 feet)
Suitable spark plug lead diameter.....	10 mm. maximum

Capacitive Secondary Pickup (PM9096/101, Europe only)

Attenuation	10000:1
Cable length	3 meters (10 feet)
Suitable spark plug lead diameter.....	6 to 8 mm

Capacitive Secondary Pickup (CAP90-2)

Attenuation	10000:1
Cable length	1.5 meter (5 feet)
Suitable spark plug lead diameter.....	> 6 mm
Clamp width	25.4 mm (1 inch)
Clamp heat-resistance	> 110°C (230°F)
HEI adapters for	GM, Toyota, Honda

10:1 Filter Adapter

(This adapter raises the input impedance of your Automotive ScopeMeter to 10 MΩ. It also eliminates noise over 4 kHz. It is useful for high impedance, low voltage measurements.)

Attenuation	10:1
Bandwidth	4 kHz
Input impedance.....	10 MΩ in parallel with 3.5 pF
Load impedance.....	1 MΩ in parallel with 30 pF
Maximum input voltage	300V

APPENDIX 7B Parts and Accessories

Service Manual

Part Number: 4822 872 05371

Replacement Parts for the Standard Kit Contents

PART	ORDERING NUMBER
Yellow Holster	PM9083/001
NiCad Battery Pack	PM9086/001
Power Adapter/Battery Charger	PM8907/80* (See Appendix 7C.) * = 1 for Universal Europe, 230V, 50 Hz * = 3 for North America, 120V, 60 Hz * = 4 for United Kingdom, 240V, 50 Hz * = 6 for Japan, 100V, 60 Hz * = 7 for Australia 240V, 50 Hz * = 8 Universal 115V/230V (US Plug)
Automotive Hard Carrying Case	C98
Shielded Test Lead STL90 (Red)	5322 321 63017
Shielded Test Lead STL90 (Grey)	5322 321 63018
Ground Leads for STL90 Shielded Test Leads (25 cm, 10 inch), Black	5322 321 63019
Ground Lead (unshielded) with banana plugs, 1.5 m, 60 inch (Black)	5322 397 60156
Ground Extension Lead (unshielded), 1.5 m, 60 inch (Black)	5322 321 61945
BNC Extension Lead for STL90	5322 321 63021
Secondary Pickup with Ground Lead, or Secondary Pickup with three HEI plates	PM9096/101 (Europe only) CAP 90-2
Inductive Pickup	RPM90
Filter Adapter (Blue)	5322 263 50246
Alligator Clips (Red and Black)	AC85A
Alligator Clip (Grey)	5322 290 40472

PART	ORDERING NUMBER
4 mm Banana Adapter (Red)	5322 263 50242
4 mm Banana Adapter (Grey)	5322 263 50239
4 mm Banana Adapter (Black)	5322 263 50241
2 mm Adapter (Red)	5322 263 50238
2 mm Adapter (Grey)	5322 263 50236
2 mm Adapter (Black)	5322 263 50237
Back Probe Pin (Red)	5322 264 20104
Back Probe Pin, (Grey)	5322 264 20105
Back Probe Pin, (Black)	5322 264 20103
Users Manual English	4822 872 00786
Users Manual French	4822 872 00787
Users Manual Spanish	4822 872 00788
Shielded Test Lead Set Consists of the following: <ul style="list-style-type: none"> ● Two Shielded Test Leads 1.5 m, 60 inch (Red and Grey) ● Two 2 mm Adapters (Red and Grey) ● Two 4 mm Banana Adapters (Red and Grey) ● Three Backprobe Pins (Red, Grey, and Black) ● Two Ground Leads for the Shielded Test Leads (25 cm, 10 inch) ● Two AC85A Alligator Clips (Black) 	STL90 All parts for the STL90 Shielded Test Lead Set are included in the Standard Kit Contents and are listed above with ordering numbers.

Optional Accessories

PART	ORDERING NUMBER
AC/DC Current Probe	90i-610s
Temperature Probe	TR90
Diesel Probe Set Consists of the following: <ul style="list-style-type: none"> ● 10:1 Low Pass Filter Probe ● Probe Tip Adapter, with 2 mm tip ● Probe Tip Adapter, with 4 mm banana plug ● Two Alligator Clips (Red and Black) ● Retractable Hook Tip with Ground Lead (Red) ● Piezo Pickup, 6 mm ● Probe-to-Piezo Pickup Adapter 	DPS90 No replacement part 5322 264 20087 5322 264 20096 AC85 5322 210 70136 5322 263 50244 5322 263 50245 <div style="display: flex; align-items: center; justify-content: center; margin-left: 20px;"> <div style="font-size: 3em; margin-right: 5px;">}</div> <div style="writing-mode: vertical-rl; transform: rotate(180deg); font-weight: bold;">PM8918/301</div> </div>
Diesel Extension Set Consists of the following: <ul style="list-style-type: none"> ● Piezo Pickup, 4.55 mm ● Probe-to-Piezo Pickup Adapter 	DPE90 No replacement part 5322 263 50245
Optically isolated RS-232 Adapter/Cable (for connection to a printer or a computer)	PM9080/001
FlukeView 98 Software (Optically isolated RS-232 Adapter/Cable for connection to the computer is included)	SW98W/011
Isolated 12V Charging Adapter (fits automotive cigarette lighter socket)	PM9087/002
Isolated 24V Charging Adapter (fits automotive cigarette lighter socket)	PM9087/021

APPENDIX 7C PM8907 Information

Your ScopeMeter test tool is powered by a PM8907 Power Adapter /Battery Charger. The version you use depends on the configuration ordered.



WARNING

TO AVOID ELECTRICAL SHOCK, CONNECT THE PM8907 POWER ADAPTER TO THE AC OUTLET BEFORE CONNECTION TO THE TEST TOOL.

The following versions are used with the test tool:

- PM8907/801 Universal European line plug 230V $\pm 10\%$
- PM8907/803 North American line plug 120V $\pm 10\%$
- PM8907/804 United Kingdom line plug 240V $\pm 10\%$
- PM8907/806 Japanese line plug 100V $\pm 10\%$
- PM8907/807 Australian line plug 240V $\pm 10\%$
- PM8907/808 North American line plug and switchable line voltage 115V $\pm 10\%$ or 230V $\pm 15\%$.

The line frequencies for all units are 50, 60, and 400 Hz $\pm 10\%$.

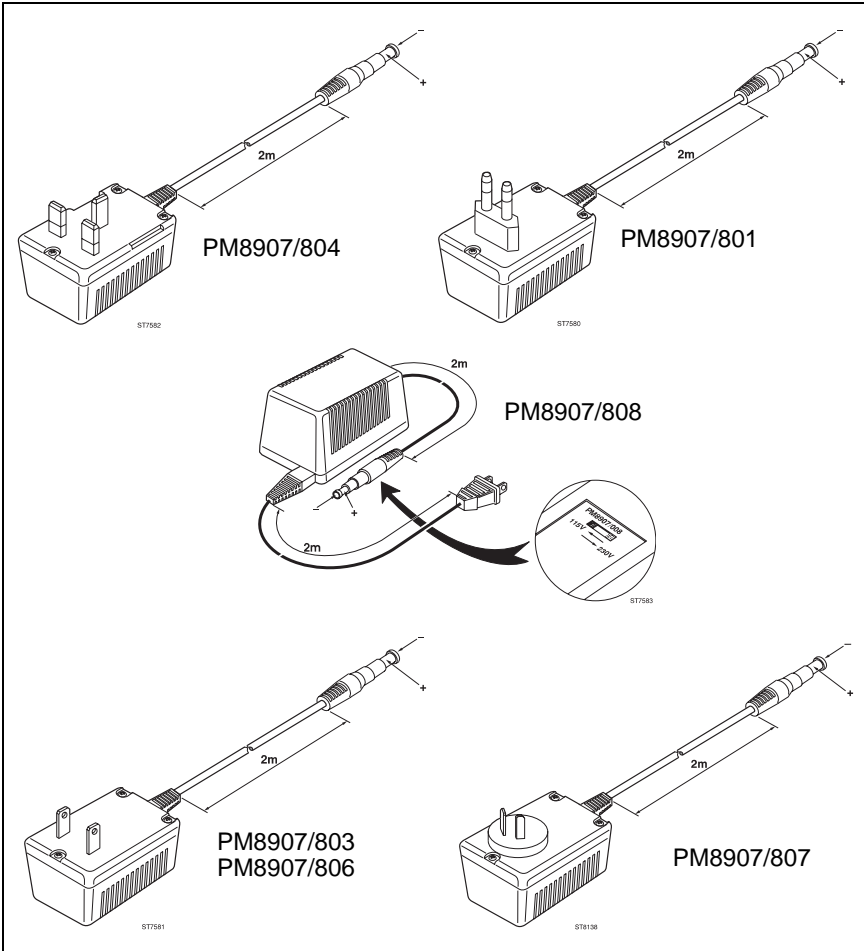

Figure 7C-1 PM8907 Versions

CAUTION

At delivery, the PM8907/808 is set to 230V and is provided with a Power Supply Cord and Attachment Plug that is for use at the 115V setting only. When operating the unit at the 230V setting, you need a North American-to-European line plug adapter.

Before you connect the PM8907/808 to the local line, first check the preselected voltage setting on this unit. You can find the voltage selector switch on the bottom of the PM8907/808. If necessary, select the corresponding line voltage with the slide switch and ensure that the proper voltage is visible in the window of the slide selector (see Figure 7C-1).

APPENDIX 7D Warranty and Service Centers

LIMITED WARRANTY & LIMITATION OF LIABILITY

Each Fluke product is warranted to be free from defects in material and workmanship under normal use and service. The warranty period is three years and begins on the date of shipment. Parts, product repairs and services are warranted for 90 days. This warranty extends only to the original buyer or end-user customer of a Fluke authorized reseller, and does not apply to fuses, disposable batteries or to any product which, in Fluke's opinion, has been misused, altered, neglected or damaged by accident or abnormal conditions of operation or handling. Fluke warrants that software will operate substantially in accordance with its functional specifications for 90 days and that it has been properly recorded on non-defective media. Fluke does not warrant that software will be error free or operate without interruption.

Fluke authorized resellers shall extend this warranty on new and unused products to end-user customers only but have no authority to extend a greater or different warranty on behalf of Fluke. Warranty support is available if product is purchased through a Fluke authorized sales outlet or Buyer has paid the applicable international price. Fluke reserves the right to invoice Buyer for importation costs of repair/replacement parts when product purchased in one country is submitted for repair in another country.

Fluke's warranty obligation is limited, at Fluke's option, to refund of the purchase price, free of charge repair, or replacement of a defective product which is returned to a Fluke authorized service center within the warranty period.

To obtain warranty service, contact your nearest Fluke authorized service center or send the product, with a description of the difficulty, postage and insurance prepaid (FOB Destination), to the nearest Fluke authorized service center. Fluke assumes no risk for damage in transit. Following warranty repair, the product will be returned to Buyer, transportation prepaid (FOB Destination). If Fluke determines that the failure was caused by misuse, alteration, accident or abnormal condition of operation or handling, Fluke will provide an estimate of repair costs and obtain authorization before commencing the work. Following repair, the product will be returned to the Buyer transportation prepaid and the Buyer will be billed for the repair and return transportation charges (FOB Shipping Point).

THIS WARRANTY IS BUYER'S SOLE AND EXCLUSIVE REMEDY AND IS IN LIEU OF ALL OTHER WARRANTIES, EXPRESS OR IMPLIED, INCLUDING BUT NOT LIMITED TO ANY IMPLIED WARRANTY OF MERCHANTABILITY OR FITNESS FOR A PARTICULAR PURPOSE. FLUKE SHALL NOT BE LIABLE FOR ANY SPECIAL, INDIRECT, INCIDENTAL OR CONSEQUENTIAL DAMAGES OR LOSSES, INCLUDING LOSS OF DATA, WHETHER ARISING FROM BREACH OF WARRANTY OR BASED ON CONTRACT, TORT, RELIANCE OR ANY OTHER THEORY.

Since some countries or states do not allow limitation of the term of an implied warranty, or exclusion or limitation of incidental or consequential damages, the limitations and exclusions of this warranty may not apply to every buyer. If any provision of this Warranty is held invalid or unenforceable by a court of competent jurisdiction, such holding will not affect the validity or enforceability of any other provision.

Fluke Corporation	or	Fluke Industrial B.V.
P.O. Box 9090		P.O. Box 680
Everett, WA		7600 AR
98206-9090		Almelo
USA		The Netherlands

Service Centers

To locate an authorized service center, visit us on the World Wide Web:

<http://www.fluke.com>

or call Fluke using any of the phone numbers listed below:

+1-800-443-5853 in U.S.A. and Canada

+31-402-678-200 in Europe

+1-206-356-5500 from other countries

APPENDIX 7E Terminology

TERM	DESCRIPTION
ABS	Antilock Brake System
AC	Alternating Current.
AC Coupling	A mode of signal transmission that passes the dynamic (AC) signal component to the input (INPUT A or INPUT B), but blocks the DC component. Useful to observe an AC signal that is normally riding on a DC signal, e.g. charging ripple.
Acquisition	The process of gathering measuring data into the test tool's memory.
Acquisition Rate	The number of acquisitions performed per second.
Alternating Current.	An electrical signal in which current and voltage vary in a repeating pattern over time.
Amplitude	The difference between the highest and lowest level of a waveform.
Attenuation	The decrease in amplitude of a signal.
Auto Range	Activates an automatic adaptation of the test tool to the input signal in amplitude, timebase, and triggering.
Backlight	Light that illuminates the test tool's display from the back of the LCD.
Baud Rate	Communication parameter that indicates the data transfer rate in bits per second.
BNC	Coaxial-type input connector used for INPUT A and INPUT B.
Bottom Display	The lower part of the display, where the function key menu is listed.
Coil On Plug Ignition System	An ignition system without a distributor, where each spark plug is integrated with an ignition coil.
Continuity	Instrument setup to check wiring, circuits, connectors, or switches for breaks (open circuit) or short circuits (closed circuit).
Contrast	This setting, expressed as a percentage, determines the contrast ratio between display text or graphics and the LCD background. 0% is all white. 100% is all black.

TERM	DESCRIPTION
Conventional Ignition System	Ignition system that uses a distributor.
Cursor	A vertical line (kind of ruler) that you can place on the and move horizontally to measure values at certain points of the waveform.
DC	Direct Current.
DC Coupling	A mode of signal transmission that passes both AC and DC signal components to the input (INPUT A or INPUT B) of the test tool. (See also AC Coupling.)
Default Setup	The setup that exists as long as there are no changes made to the settings.
Diesel Probe	A test probe that has a pickup element to measure the pressure pulse in the diesel fuel pipe. It converts fuel pipe expansion into voltage.
Differential Measurement (delta)	Measurement of the difference between the waveform sample values at the positions of the two cursors.
Diode	An electrical device that allows current to flow in one direction only.
Direct Current	A signal with constant voltage and current.
DIS	Distributorless Ignition System.
Division	A specific segment of a waveform, as defined by the grid on the display.
Dot	One, two, or three vertically adjoining display pixels, depending on the dot size, forming a graphical unit for waveform display.
Duty Cycle	On-time or off-time to period time ratio expressed in a percentage.
ECM	Electronic Control Module on a vehicle.
ECU	Electronic Control Unit on a vehicle.
EIA-232-D/RS-232-C	International standard for serial data communication to which the optical interface (PM9080) of the FLUKE 98 conforms.
Electromagnetic Interference	Mutual disturbance of signals, mostly caused by signals from adjacent wiring.
EMI	Electromagnetic Interference.

TERM	DESCRIPTION
Feed Controlled Circuit	A circuit that energizes by applying voltage; it already has a ground.
Filter	Electrical device that only passes or blocks certain signal frequencies. An application can be removing noise from a signal.
Frequency	The number of times a waveform repeats in one second, measured in Hertz (Hz), where 1 Hz equals one cycle per second.
Function Key Labels	Labels shown on the bottom display that indicate the function of the blue function keys F1 to F5.
Function Key Menu	The function key labels listed on the bottom display.
Glitch	A momentary spike in a waveform. This can be caused by a momentary disruption in the tested circuit.
Ground-Controlled Circuit	A circuit that energizes by applying ground; voltage is already supplied.
Hall-Effect Sensor	A semiconductor moving relative to a magnetic field, creating a variable voltage output. Used to determine position.
Inductance	The signal caused by the sudden change of a magnetic field. For example when you turn off the current through a solenoid, a voltage spike is generated across the solenoid.
Intermittent	Irregular; a condition that happens with no apparent or predictable pattern.
Invert	To change to the opposite polarity. Puts the waveform display upside down.
Lambda Sensor	Oxygen sensor or O ₂ sensor.
Liquid Crystal Display	A display that uses liquid crystals to display waveforms and text on its screen.
LCD	Liquid Crystal Display.
Master Reset	Resets the test tool to the factory "Default Set-up." You can do this by turning power on while pressing the F5 function key.
Menu	A list of choices for selecting a test, a function, or a setting.

TERM	DESCRIPTION
Noise	Extraneous electrical signal that can interfere with other electrical signals. The noise can disturb the function of the signal when it exceeds a certain electrical level.
NTC	A resistor that has a Negative Temperature Coefficient; resistance decreases as temperature increases.
O ₂ Sensor	Oxygen sensor.
Off-time	The part of an electrical signal during which an electrical device is energized.
On-time	The part of an electrical signal during which an electrical device is de-energized.
Optically Isolated RS-232 Adapter/ Cable	An accessory that allows data communication between the FLUKE 98 and a computer with RS-232 (serial) port, or it allows you to print.
Peak Value	The highest and lowest value of a waveform.
Peak-and-Hold	A method for regulating the current flow through electronic fuel injectors. Supplies higher current necessary to energize the injector, then drops to a lower level just enough to keep the injector energized.
Pixel	The smallest graphic detail possible for the liquid crystal display (<i>LCD</i>).
PTC	A resistor having a Positive Temperature Coefficient; resistance increases as temperature increases.
Pulse	A voltage signal that increases or decreases from a constant value, then returns to the original value.
Pulse Modulated	A circuit that maintains average voltage levels by pulsing the voltage on and off.
Range	Specified limits in which measurements are done.
Reference Voltage	An unaltered voltage applied to a circuit. Battery plus and ground are examples of reference voltages.
Roll	Visual log of a waveform activity that is useful when measuring lower frequencies.
Root Mean Square (RMS)	Conversion of AC voltages to the effective DC value.
RPM	Engine speed expressed in Revolutions Per Minute of the crankshaft.

TERM	DESCRIPTION
RS-232-C/EIA-232-D	International standard for serial data communication to which the optical interface of the FLUKE 98 conforms.
Sample	A reading taken from an electrical signal. A waveform is created from a successive number of samples.
Sampling Rate	The number of readings taken from an electrical signal every second.
Saturated Driver	Fuel injection circuit that maintains the same voltage level throughout its on-time. See 'Injector.'
Secondary Pickup	An accessory that can be clamped on the high voltage coil wire used to measure secondary ignition patterns.
Shielded Test Lead	A test lead that is surrounded by a conductive screen to protect the measurement signal against environmental influences, such as electrical noise or radiation.
Spike	A (high) voltage pulse during a short period of time (sharp pulse).
Timebase	The time defined per each horizontal division on the display.
Trace	The displayed waveform that shows the variations of the input signal as a function of time.
Trigger	Determines the beginning point of a waveform.
Trigger Level	The voltage level that a waveform must reach to start display.
Trigger Slope	The voltage direction that a waveform must have to start display. A positive Slope requires the voltage to be increasing as it crosses the <i>Trigger Level</i> ; a negative Slope requires the voltage to be decreasing.
Trigger Source	The test tool input that supplies the signal to provide the <i>trigger</i> .
Vertical Scale	The scale used for vertical display (vertical sensitivity) expressed in certain units per division.
Voltage Drop	Voltage loss across a wire, connector, or any other conductor. Voltage drop equals resistance in ohms times current in amperes (Ohm's Law).
Waveform	The pattern defined by an electrical signal.

A

AC coupling	3-40
Adapters	VI, 3-4
Advance	3-26
Advance (Diesel)	3-29
Air Flow Sensors	5-37
Alligator Clips	VI, 3-5
Amplitude	1-14
Anti-Lock Wheel Speed Sensor	5-33
Auto Range	1-3, 1-15, 3-39, 3-48
Automatic Power Shutdown	1-12

B

Back Probe Pins	VI, 3-5
Backlight	1-14, 2-3
Banana Adapters	3-5
Batteries in Optimal Condition	6-2
Battery Charger	V, 7-17
Battery Life	1-12
Battery Replacement	6-5
Battery Test	3-32, 5-79
Baud Rate	3-60
BNC Extension Leads	VI
Burn Time	3-24, 3-25
Burn Voltage	3-24, 3-25

C

Calibrating the Test Leads	3-62, 6-6
Charging	3-31, 5-81
Charging Adapter	1-11
Charging Current	3-31
Charging the Batteries	6-2
Charging the Battery	1-12
Charging Voltage	3-31
Clamping Diode Test	5-85
Cleaning	6-2
Compression Test	5-73
Compression test	3-45
Connection Help	1-10, 3-9, 3-61
Connection Information	1-10
Connections	1-19
Continuity	3-49

Contrast	1-14, 2-3, 3-58
Conventional Systems	3-24, 3-25
Coolant Temperature Sensor	5-13
Crankshaft/Camshaft Position	5-21
Current	3-54
Current Probe	1-3, 3-5, 3-62
Cursors	1-14, 1-15, 2-32, 4-14

D

Damping	1-14
DC Coupling	3-40
Demo Board	VI, 2-2
Diesel	5-92
Diesel Advance	5-96
Diesel Extension Set	3-6
Diesel Injection Pattern Display	5-94
Diesel Injector	3-28
Diesel Probe Set	3-6
Diesel RPM Measurements	5-94
Diesel Test Functions	3-28
Diode	3-49
Display Contrast	1-7
Display Recorded Signal	4-9
Disposing of Batteries	6-4
Distributor Triggering	5-69
Distributorless Ignition System	5-60
Divisions	3-12
Dot Join	3-58
Dot Size	3-58
Dual Input Scope	3-38
Duty Cycle	3-52
Dwell	3-27, 5-67

E

Electrical System	3-30
Environmental Data	7-1
Exhaust Gas Recirculation	5-43

F

Filter Adapter	3-4
Filter Adapters	VI
Free Run	3-43, 3-44
Freeze	1-15

Frequency	3-52
Fuel Injection	5-46
Function Key Labels	1-14, 3-10
Function Key Menu	1-16, 1-17
Function Keys	1-14, 3-10
Fuses	6-5

G

Glitch Detection	3-40, 3-41, 4-16
Glitches	1-14
Graticule	3-12
Ground Extension Lead	VI
Ground Lead	3-4
Ground Lead Extension	3-4
Ground Leads	VI
Grounding	1-22
Grounding Guidelines	1-21

H

Hard Carrying Case	V
HEI Adapter	VI, 3-4, 5-65
HOLD	1-15, 4-12
Holster	V
Horizontal Range	1-17
Horizontal Timebase	3-12

I

Idle Air Control / Idle Speed Control	5-54
Inductive Pickup	VI, 3-4
Information Key	1-10, 1-14, 1-16, 1-18
Instrument Setup Overview	3-56
Intake Air Temperature Sensor	5-13
Inverse Video	3-59

K

Key Descriptions	1-14
Keypad Overview	1-13
Knock Sensor	5-57

L

Language	3-61
Limitation of Liability	7-19
Low Pass Filter Probe	3-6

M

Manifold Absolute Pressure (MAP)	5-3
Master Reset	1-7, 2-3
Menu Overview	3-8
Min/Max Trendplot	1-3, 4-2, 4-6
Mixture Control Solenoid	5-52
Multimeter Functions	3-47

N

Navigating the Menu	3-9
NiCad Battery Pack	V, 1-6, 1-11, 6-2
Noise	1-14
Noise Pickup	1-21
Noise Rejection	1-11
Numerical Results	1-17

O

On-Line Help	1-16
Optional Accessories	7-16
Optional Probes	3-5
Options Menu	3-58, 3-61
Oxygen Sensor	5-6

P

Parade Result Screen	3-24, 3-25
Parts and Accessories	7-14
Performance Characteristics	7-1
Piezo Pickup	3-6
Plot Readings	1-3, 4-2
Power Adapter/Battery Charger	V, 1-6, 1-11, 1-12, 7-17
Power Sources	1-11
Powering the Test Tool	1-6, 1-11, 2-3
Primary Ignition	5-67
Print Grey	3-60
Printer Menu	3-60
Printer Settings	3-60
Printer Type	3-60
Probe Identification	3-39
Probes	3-3
Pulse Width	3-52

R

Ranging	1-15, 3-12
Record Functions	1-14, 4-2
Relative Compression	1-3, 3-45, 5-73
Replacement Parts	7-14
Replacing the Batteries	6-4
Resetting the Test Tool	1-7
Resistance measurement	2-7, 3-49
Ride Height (Position)	5-26
Ripple Voltage	3-31
RMS Voltage	3-48
Road Test	1-3
RPM	3-51

S

Safety Characteristics	7-1
Safety Grounding	1-20
Safety Precautions	VI
Save/Recall	1-15, 2-29
Scope Functions	3-37
Secondary Ignition	5-60
Secondary Pickup	3-3, 3-62
Service Centers	7-19
Set Zero	3-48
Shielded Test Leads	VI, 1-11, 3-3
Signal Noise	1-11
Single Cylinder Result Screen	3-24, 3-25
Single Input Scope	3-38
Single-Shot Function	3-42
Smooth	4-16
Solenoid and Clamping Diode	3-34
Solenoid Test	5-85
Spark Voltage	3-25
Specifications	7-1
Spikes	1-14
Standard Kit Contents	7-14
Symbols	VII

T

TDC Sensor	3-26, 3-29
Temperature	3-55, 5-13

Temperature Probe	1-3, 3-6, 3-55, 3-62
Terminology	7-21
Test Lead Setup	3-62
Test Leads	3-3
Throttle Body Injection System	5-50
Throttle Position Sensor	5-16
Timebase	1-14, 1-15, 3-12, 3-39
Timing Advance	5-76
Trace Persistence	3-59
Trigger Control Functions	3-43
Trigger Level	1-14, 3-39, 3-43, 3-44
Trigger Slope	3-44
Trigger Source	3-39, 3-44

U

Unpacking	V
-----------------	---

V

Vehicle Data	3-57
Vehicle Speed Sensor	5-29
Vertical Range	1-17, 3-12, 3-39
Volt DC, AC	3-48
Voltage Drop	3-35, 5-88
Voltage Reference and Ground	5-90
Voltage Test	2-5

W

Warranty	7-19
Waveform	1-14